

all-occasion Face Masks

Templates
included!



Disclaimer: This is not a
medical-grade mask.

HOBBY LOBBY®



Valentine's Day

Make a mask Valentine's Day-ready with iron-on embellishments. Cut out hearts, stripes and letters from solid-colored or glittered vinyl transfer sheets. Then layer the shapes into eye-catching designs.



St. Patrick's Day

One of the simplest ways to embellish a mask is with handmade appliques. There's no need to sew or iron anything on—just use fabric glue to apply seasonal creations made of felt or fabric. P.S. The gold coins are sequins threaded with seed beads.

Easter

Prepare the little ones for an egg hunt with this trio of Easter Sunday lovelies. Embellish and outline handmade iron-on accents with embroidery stitches for a look that pops (and hops!).

Tip: Create a springtime vibe with pale colors and gingham patterns.





Mother's Day

Transform Mom's go-to mask into a functional fashion statement with a DIY lanyard. Just add alphabet beads (for a Mother's Day message) to a bead strand (tassels included!), and bring it all together with lanyard clips.



Father's Day

Create a long-lasting strap with paracord—it's durable and adjustable! Just secure it with cord stoppers for an instant one-size-fits-all strap. P.S. Up the customization factor for Father's Day with classic fabrics and DIY vinyl decals.



Bandana Mask

Stay safe and stylish with this mask-and-shawl combo! Both pretty and practical, the dual-purpose design keeps the mask tucked under the fabric but always at the ready. P.S. Giving a mask pleats allows the fabric to expand and fully cover the nose and chin.





Costume Face Shields

Get the kiddos ready for their next costume party or birthday celebration with an in-theme face shield. From an astronaut to a fairy princess, fantasies become reality with flexible quilters plastic, foam sheets and a little super glue to hold everything together!



Graduation Accessories

Gear up for graduation by customizing masks and accessories with iron-on appliques, enamel pins and rhinestone buttons. These pieces make it quick and easy to add a personal touch to both DIY (mask and sanitizer holder) and readymade (pouch) accessories.

4th of July

Create a coordinating look just in time for fireworks with these patriotic masks. And don't forget a star-spangled headband to enhance the ensemble! For the polka dot stars, apply fusible web to the backside of the fabric, cut out the stars, and iron them on. Simple as that!

Outline the stars with a stem stitch for a professional-looking border.





Fall Masks

Autumn-inspired embroidery is a great way to get a DIY mask ready for fall festivities! Just place the fabric in an embroidery hoop and stitch something seasonal.

Tip: *It's easiest to embroider before cutting out the mask shape.*



Wedding Masks

When it's time for the big day, use DIY embellishments to get masks coordinated with the wedding attire. Give his-and-hers masks a bit of elegance with iron-on metallic vinyl and, just for the bride, some beaded lace trim.



Animal Hoodies

Keep youngsters warm and comfortable with a fleecy (and furry!) hoodie-and-mask combo! These cuddly animal headpieces and face coverings are a great way to stay snug during any outdoor activity—from camping to playing at the park to backyard gatherings.

Use Simplicity 9005 to make the hoodies, and DIY the koala and cat masks out of felt pieces and iron-on vinyl.





Christmas

Safely celebrate during Christmas get-togethers with a set of cozy buffalo check masks. Try adding pompom trim for a fun and festive feel. And keep the masks nestled away in this DIY carrying case that doubles as a family keepsake!



Sweater Mask

Here's a festive face covering that's purr-fect for anyone with a kitty-cat companion. This sweater-inspired mask is designed to look embroidered, but the lettering is actually flocked vinyl that's been cut with a cutting machine and ironed onto the fabric.

PINCH FACE MASK PATTERN

ADULT SIZE (1 of 3)

SCALED AT 70%

See 2-3 for full-size template

This Pattern Works For:

Graduation, Easter & Buffalo Check Christmas

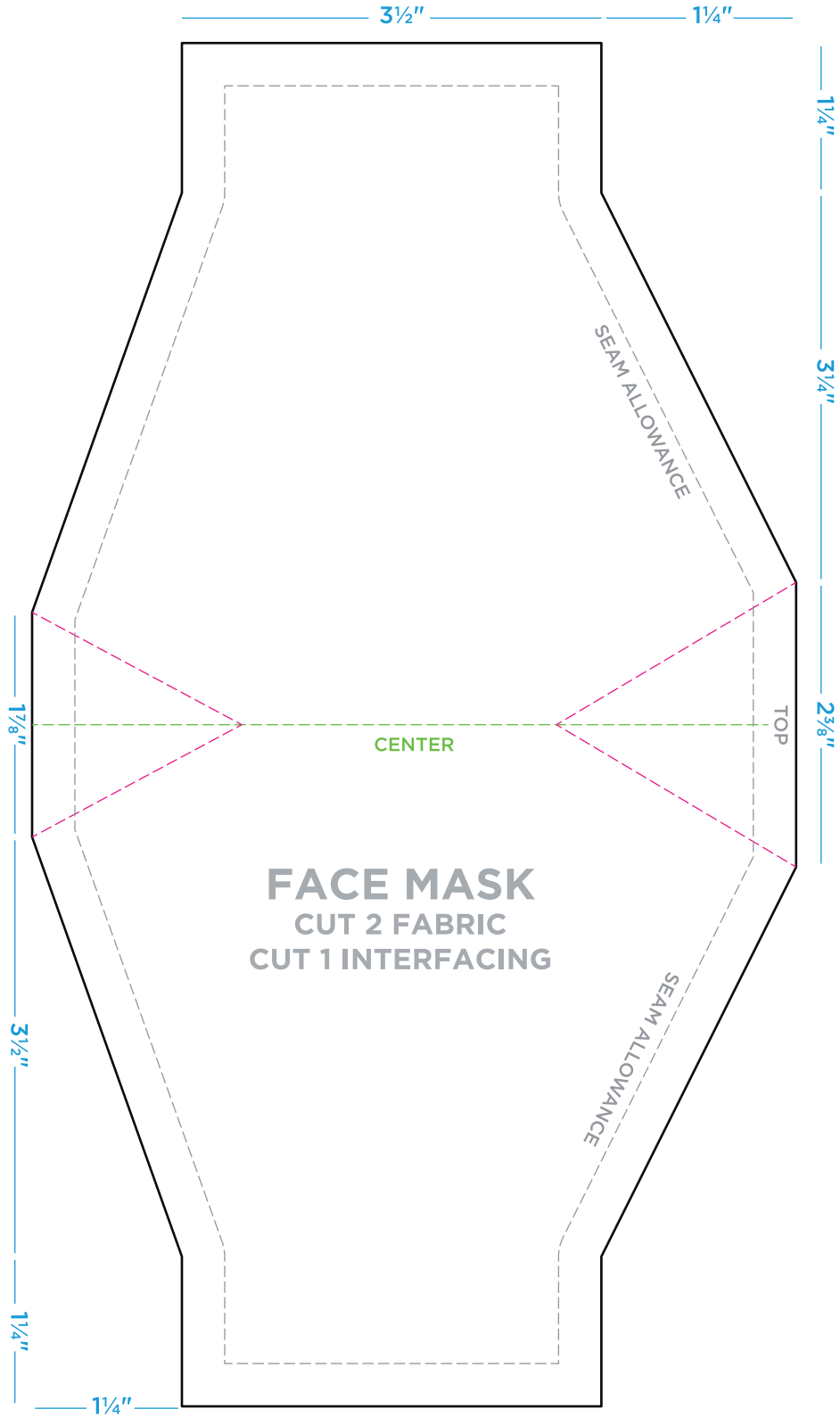

PINCH FACE MASK PATTERN

ADULT SIZE (2 of 3)

For full-size template,
cut out all pieces

Align arrow ends and
tape template together

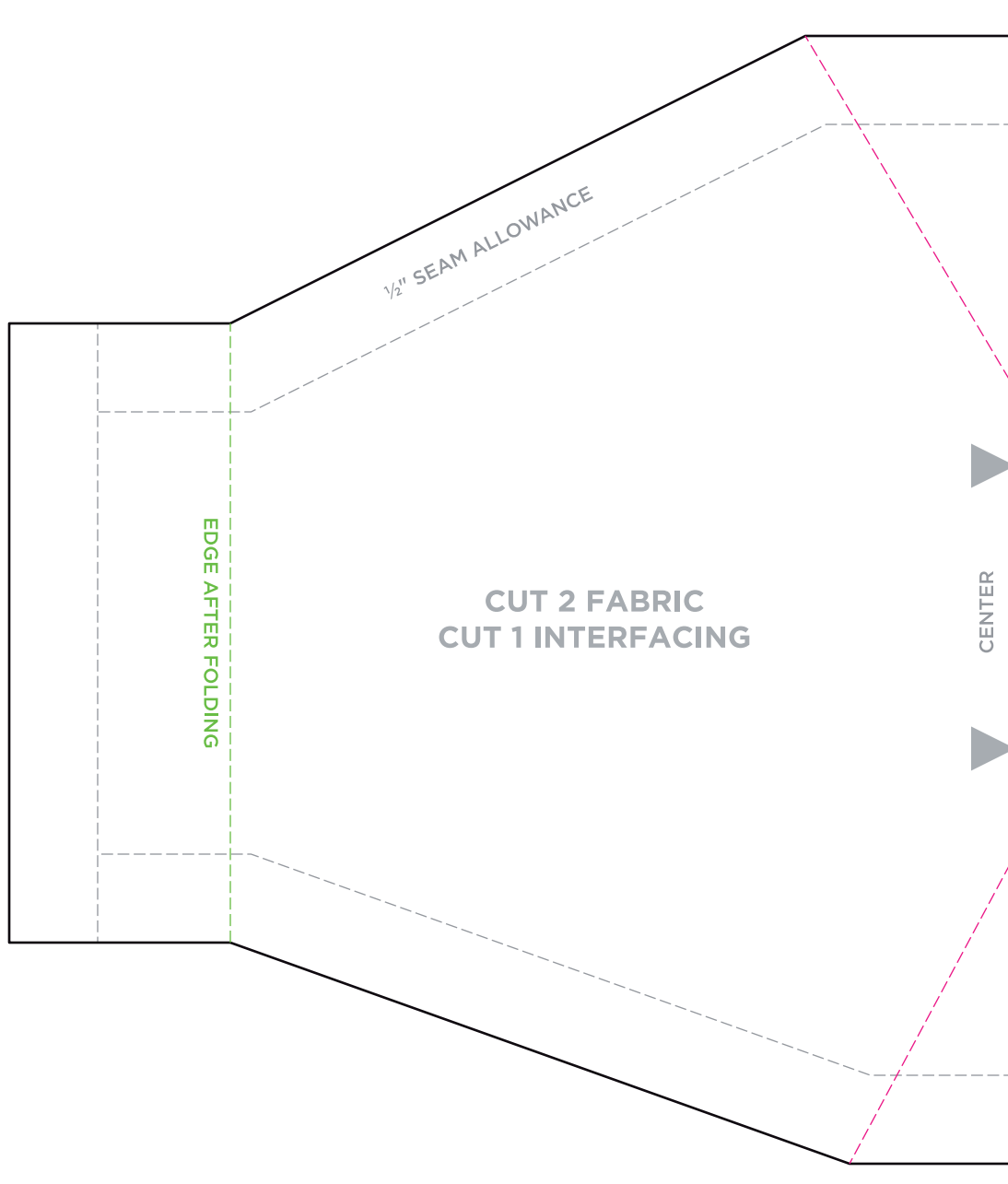

PINCH FACE MASK PATTERN

ADULT SIZE (3 of 3)

For full-size template,
cut out all pieces

Align arrow ends and
tape template together

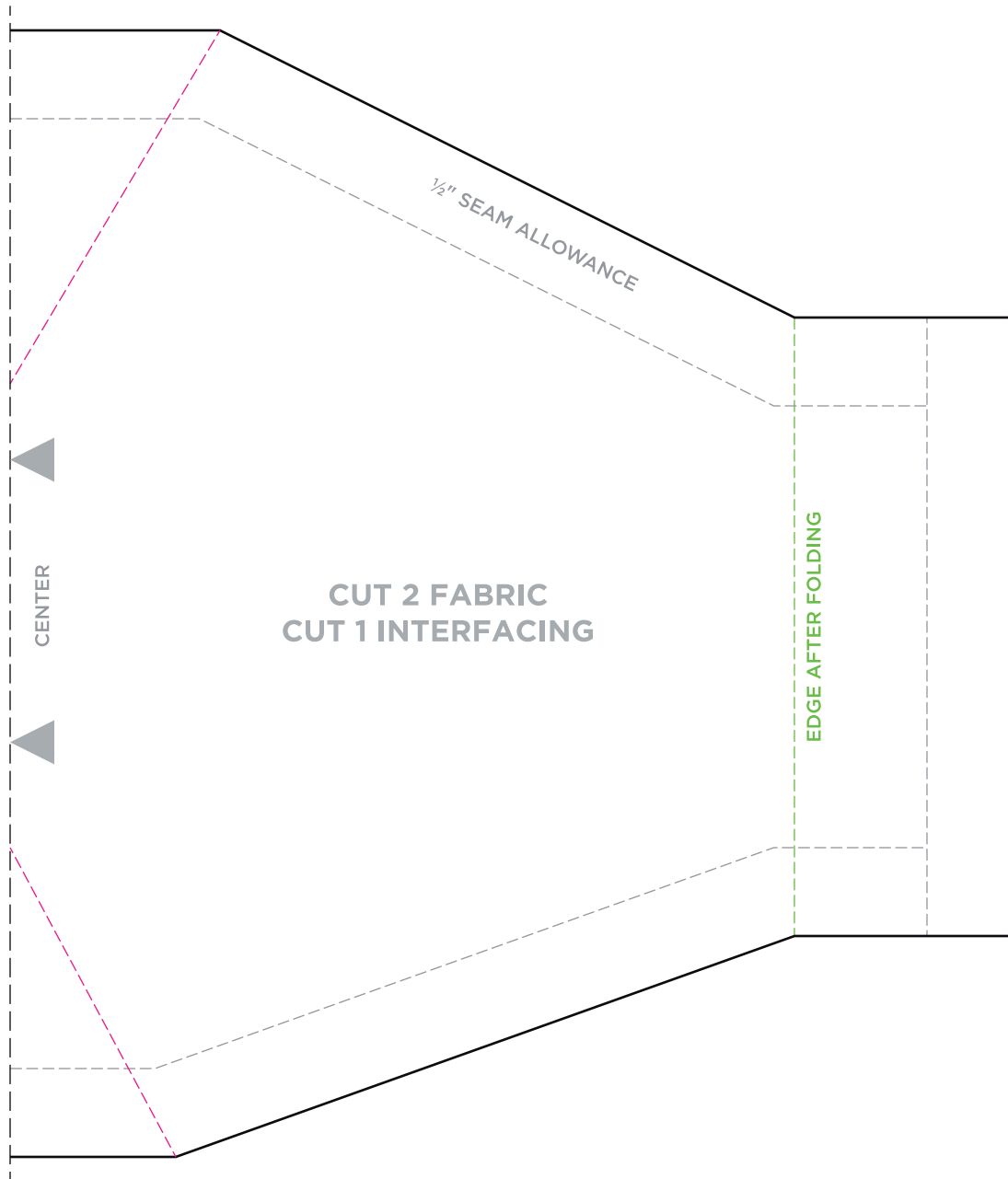

PINCH FACE MASK PATTERN

CHILD SIZE

SCALED AT 100%
See 2-3 for full-size template

This Pattern Works For:
Easter, Astronaut &
Buffalo Check Christmas

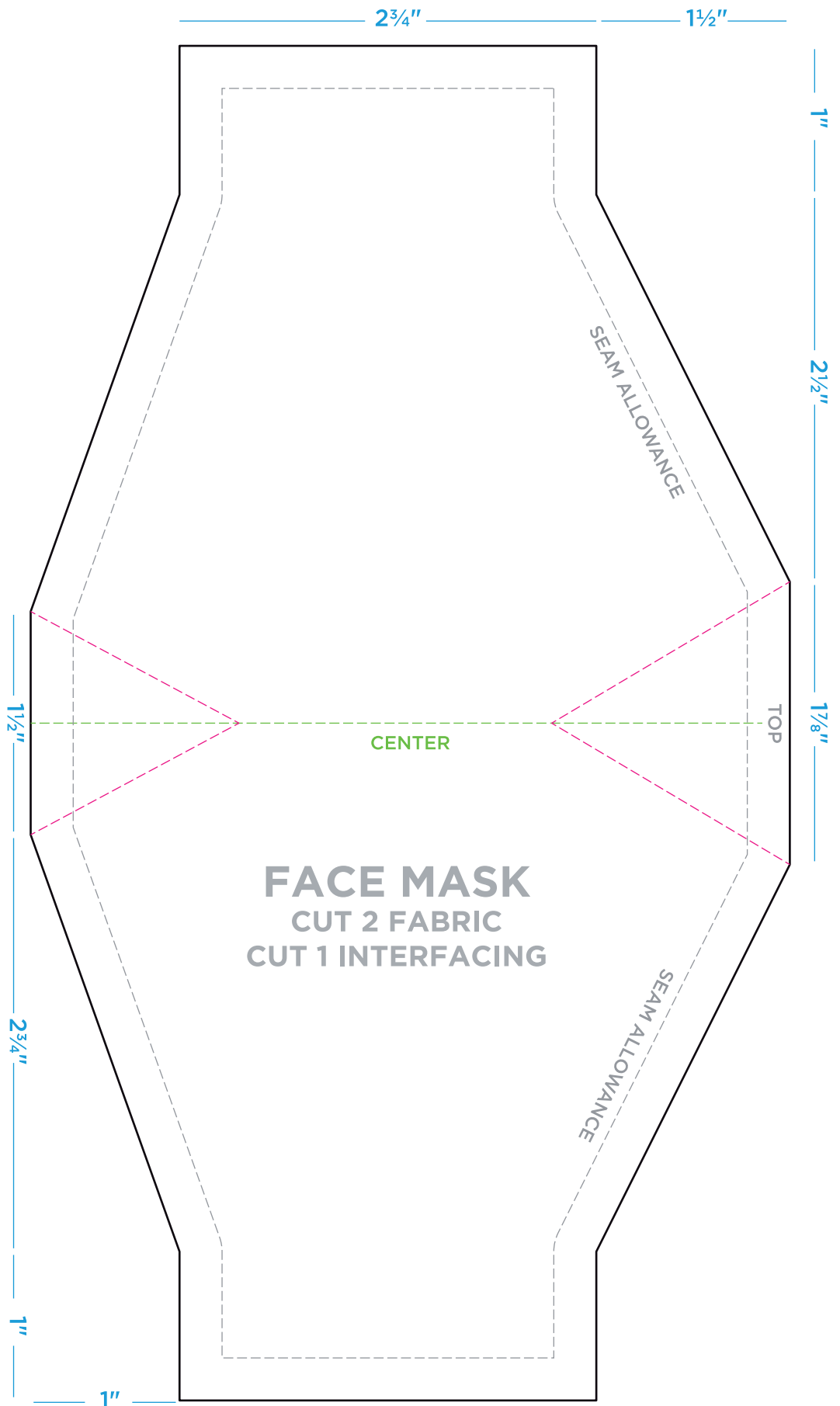

FACE MASK PATTERN

EASTER MASK (1 of 1)

SCALED AT 100%

Pair with Pinch Face Mask Pattern

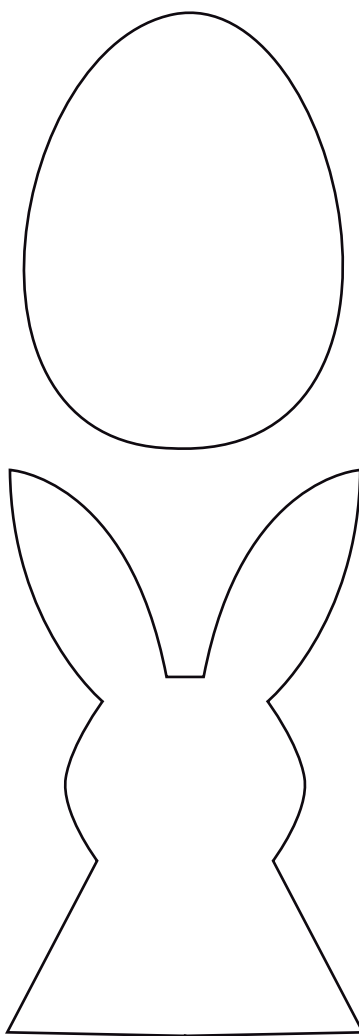

REGULAR FACE MASK PATTERN

UNISEX SIZE (1 of 4)

SCALED AT 75%

See 2-4 for full-size template

This Pattern Works For:
Father's Day & Sweater Mask

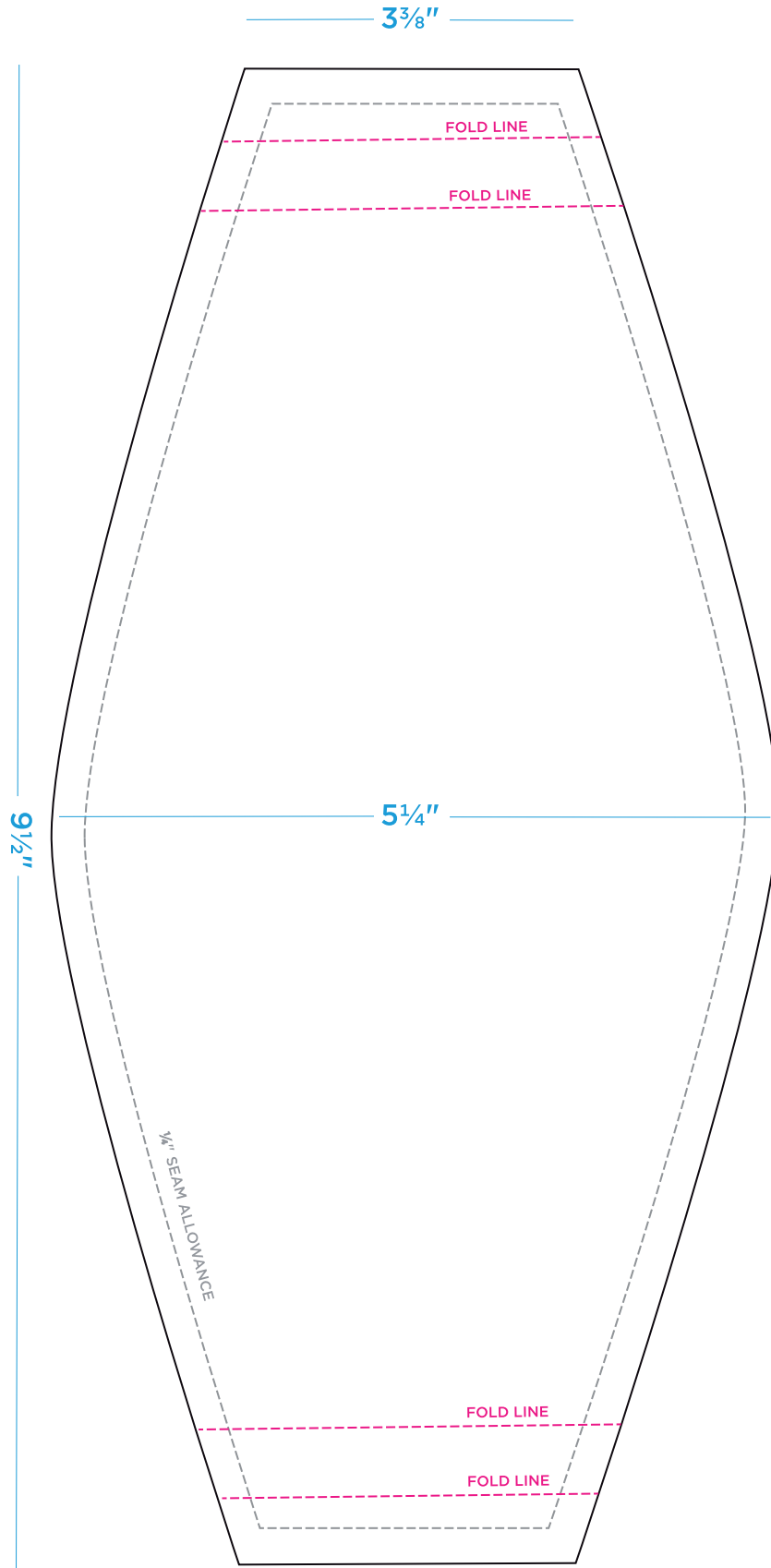

REGULAR FACE MASK PATTERN

UNISEX SIZE (2 of 4)

For full-size template,
cut out all pieces

Align arrow ends and
tape template together

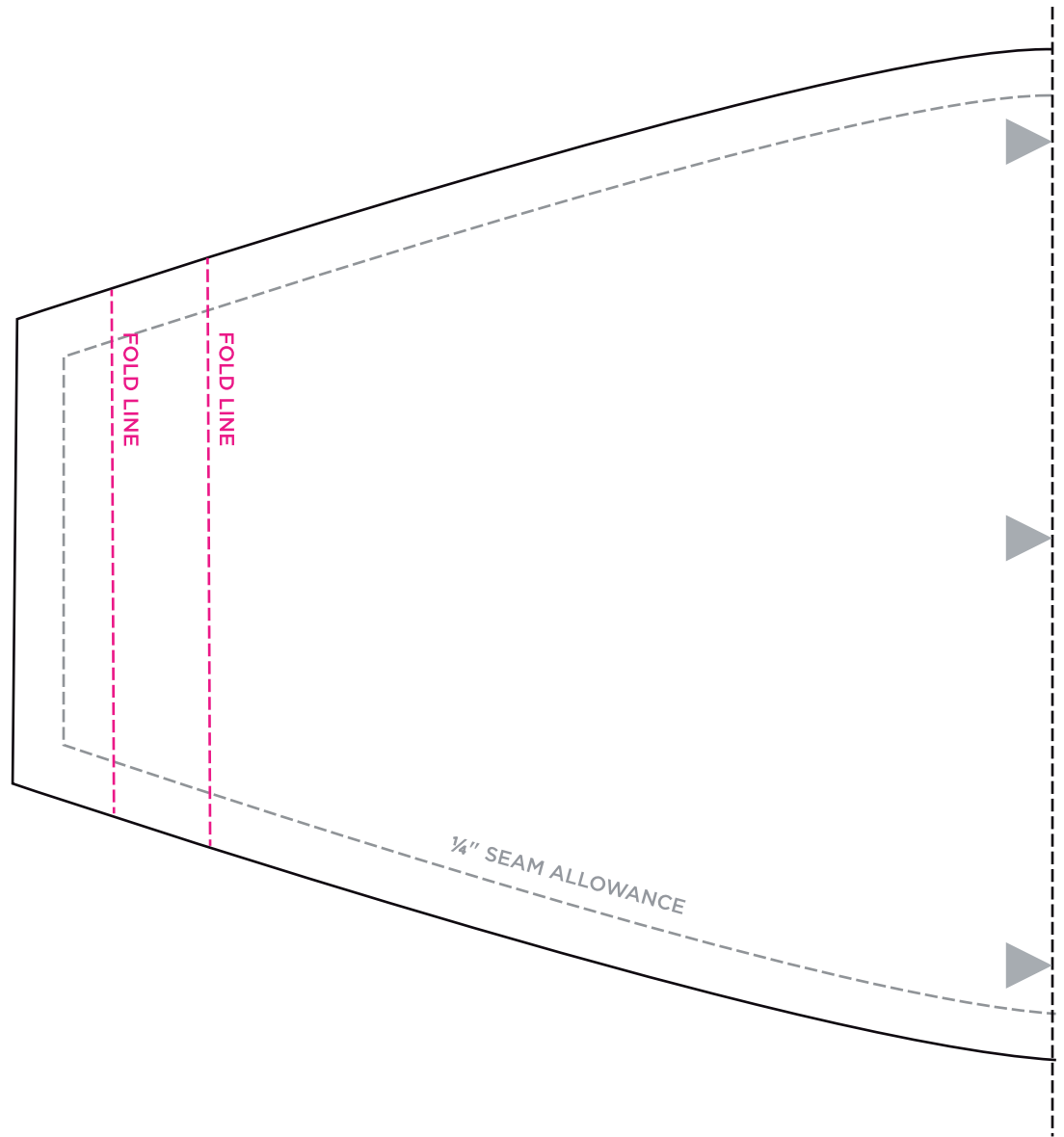

REGULAR FACE MASK PATTERN

UNISEX SIZE (3 of 4)

For full-size template,
cut out all pieces

Align arrow ends and
tape template together

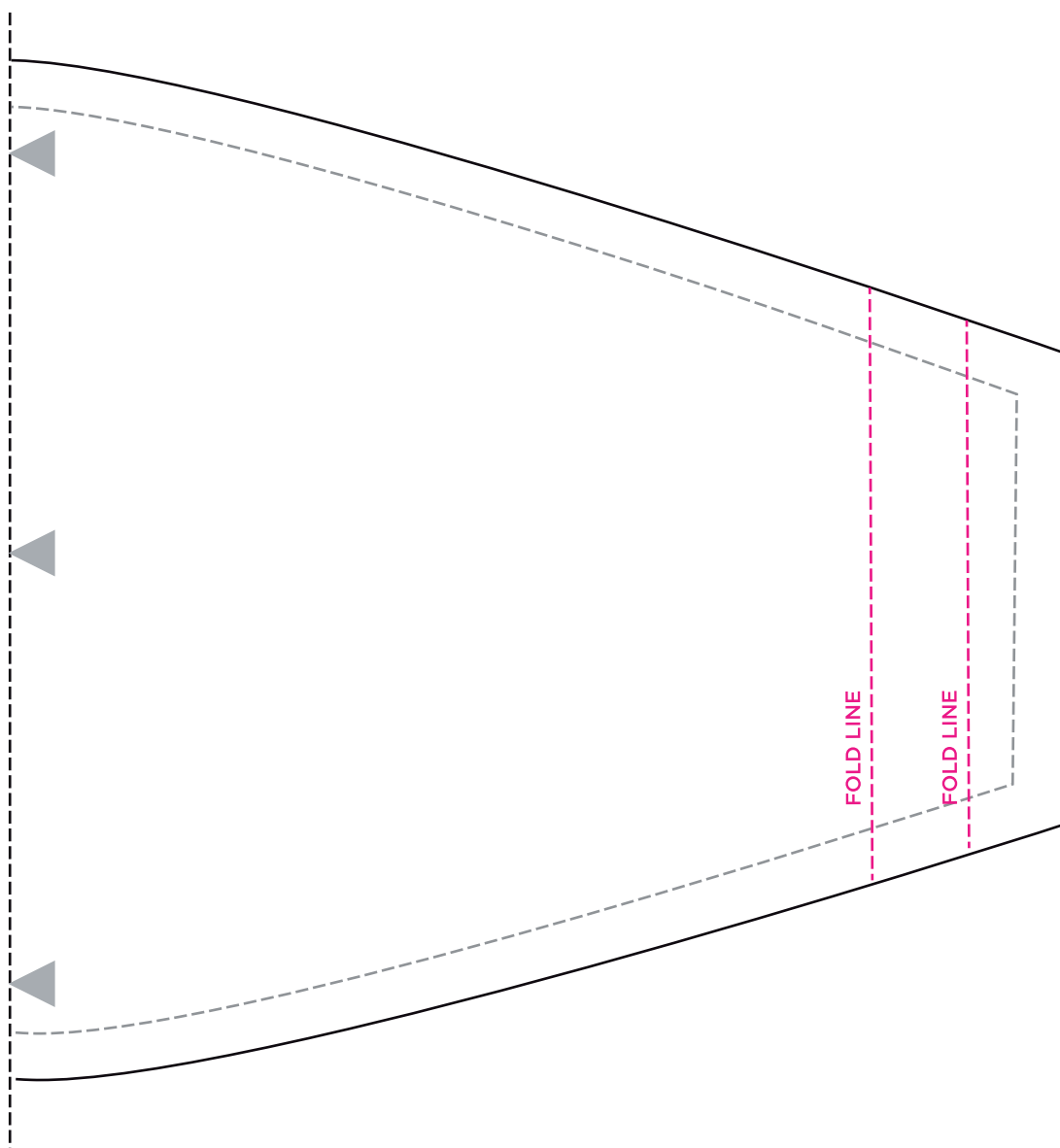

REGULAR FACE MASK PATTERN

UNISEX SIZE (4 of 4)

SCALE TO FIT

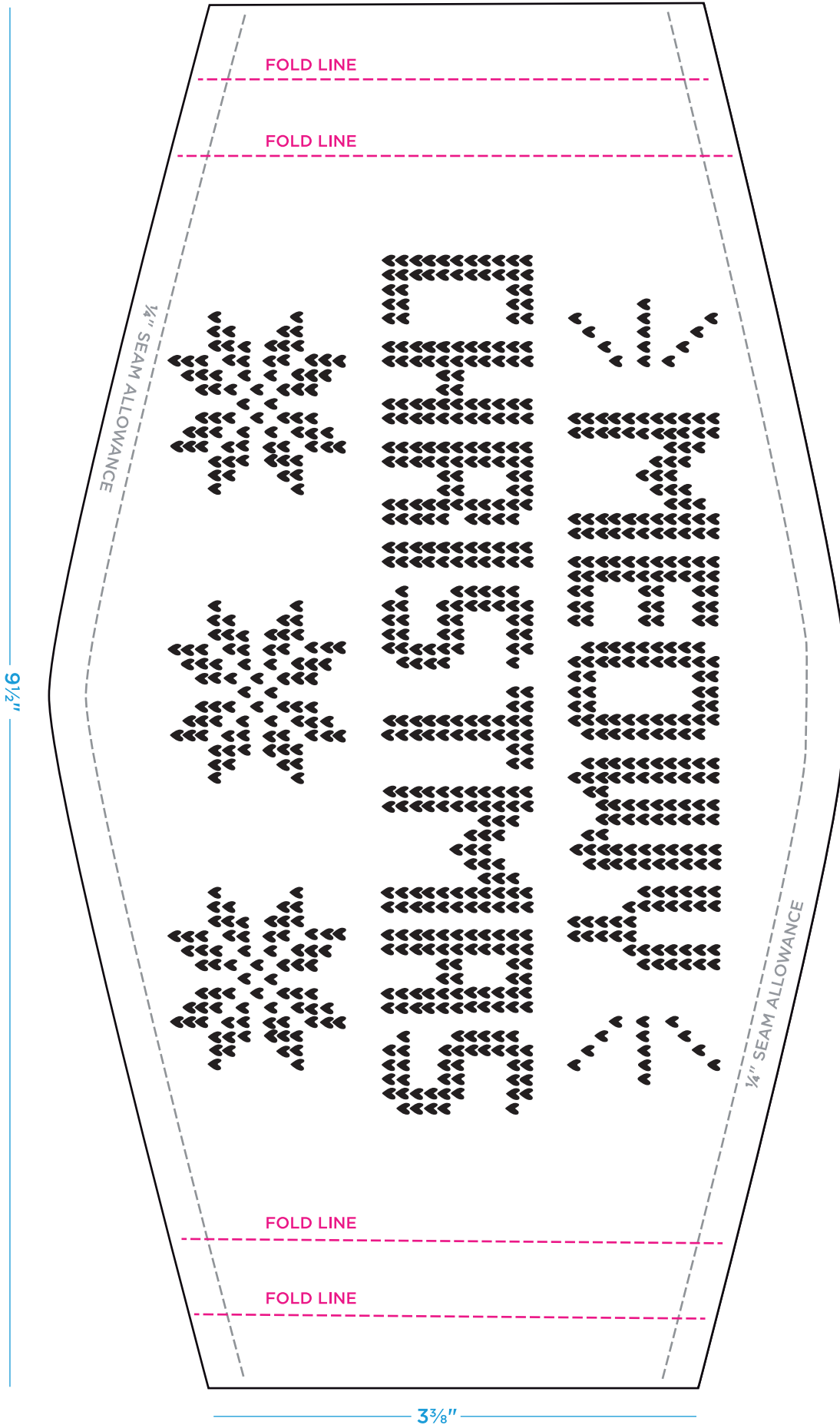

PLEATED FACE MASK PATTERN

ADULT SIZE (1 of 3)

SCALED AT 60%

See 2-3 for full-size template

This Pattern Works For:
Mother's Day & Bandana Mask

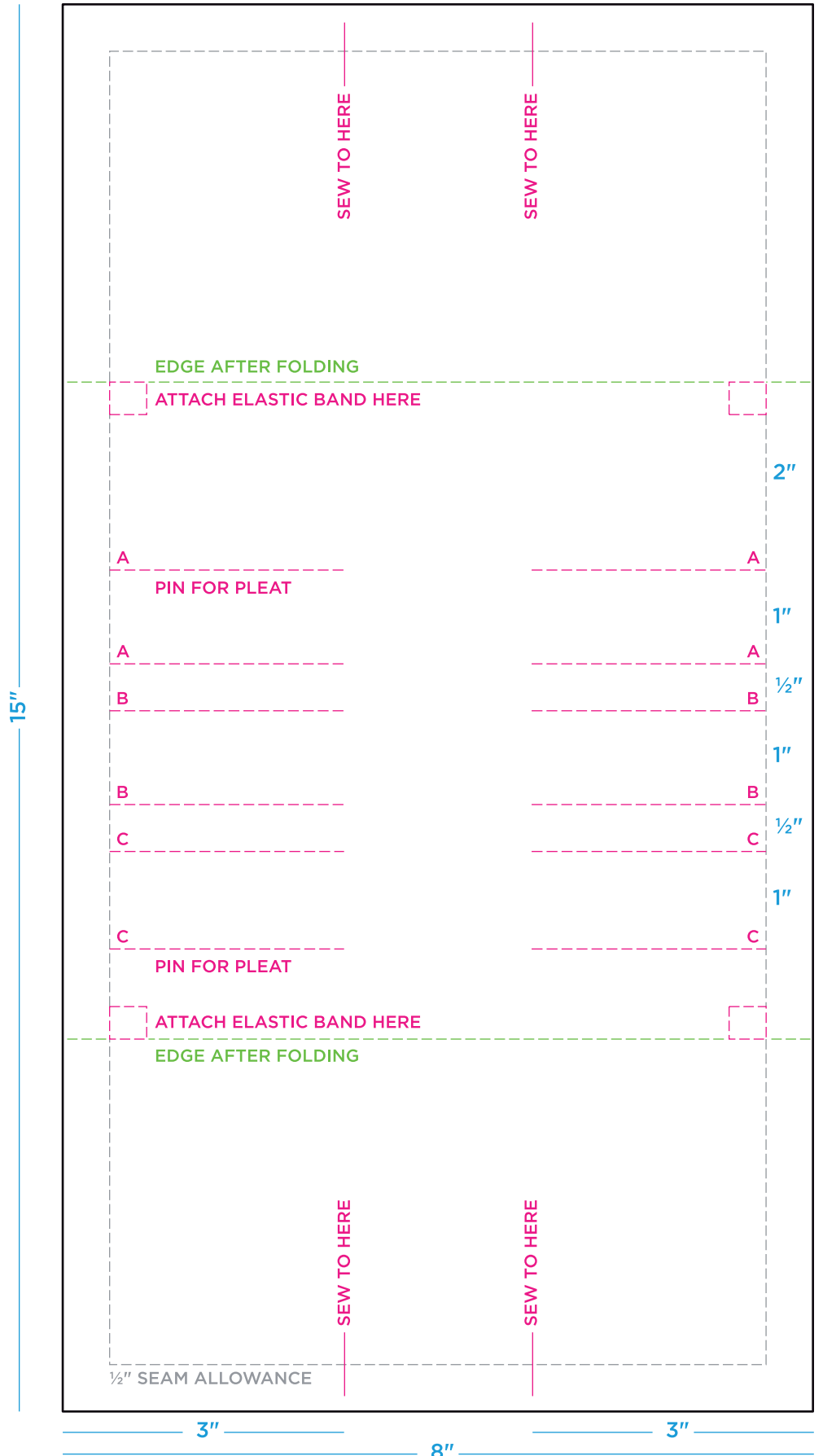

PLEATED FACE MASK PATTERN

ADULT SIZE (3 of 3)

For full-size template,
cut out all pieces

Align arrow ends and
tape template together

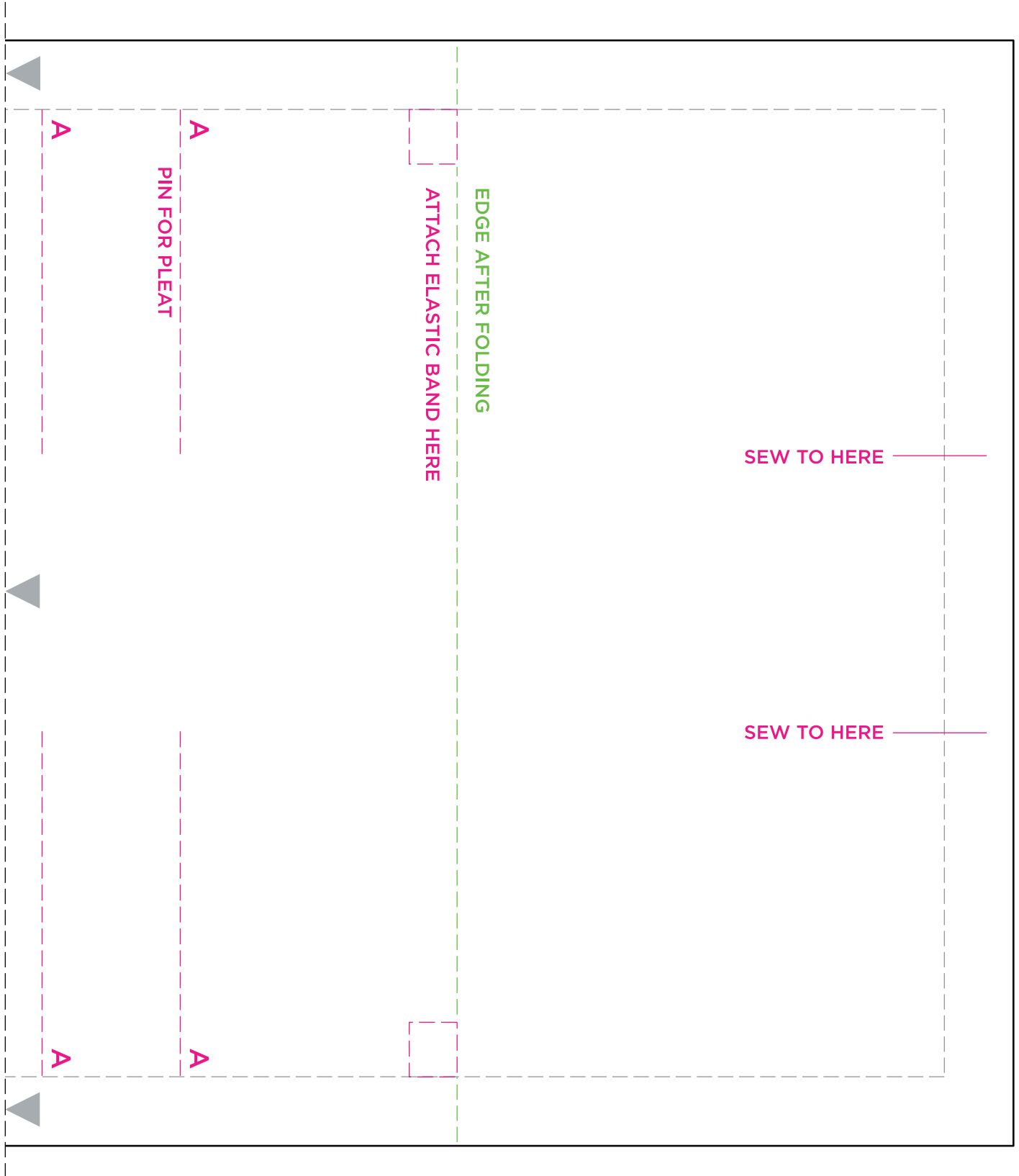

BANDANA MASK PATTERN

(1 OF 1)

SCALED AT 20%

Pair with Pleated Face Mask Pattern

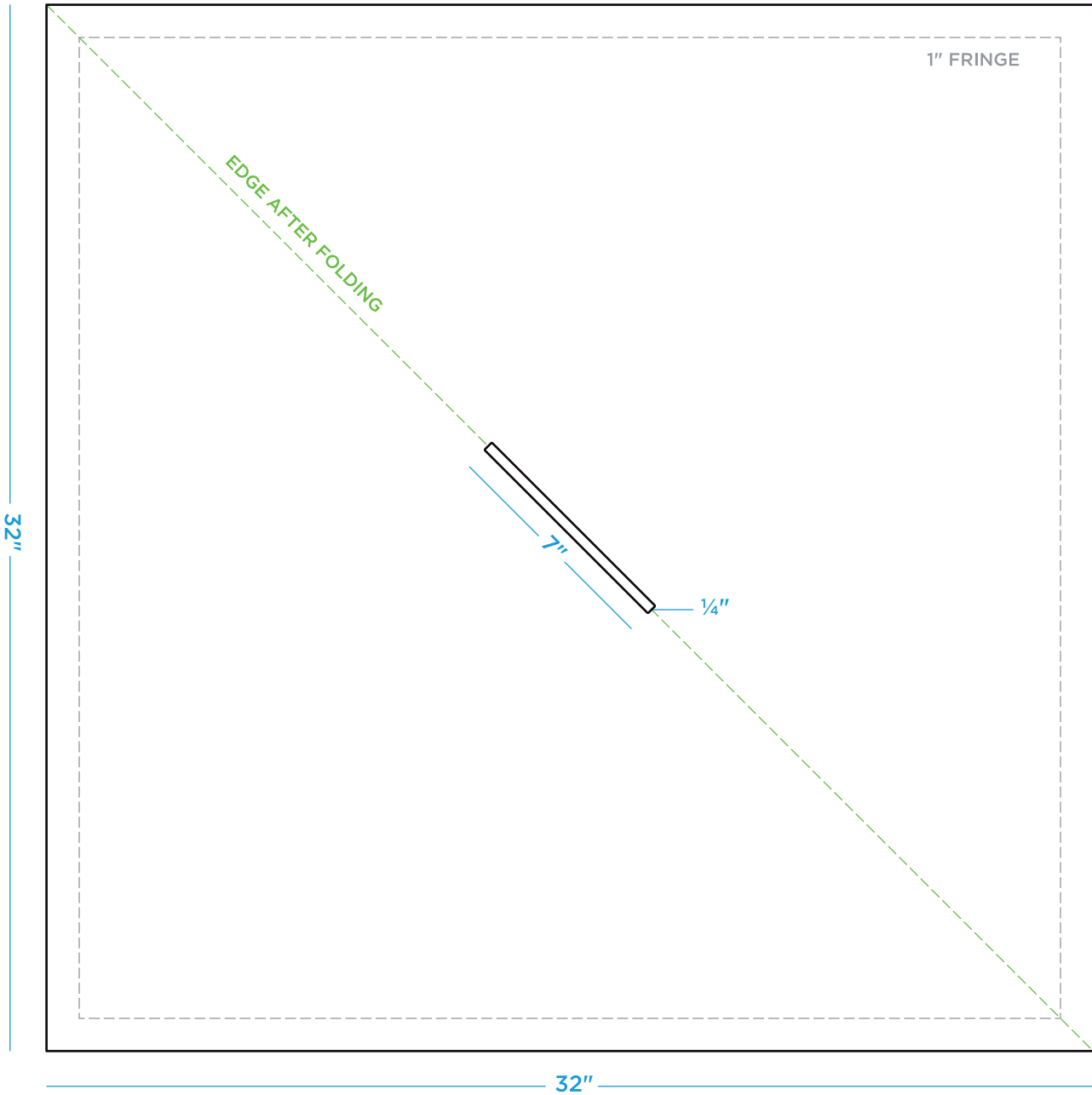

CONE FACE MASK PATTERN

SMALL/MEDIUM SIZE

SCALED AT 100%

This Pattern Works For:

St. Patrick's Day, Valentine's Day, 4th of July,
Fall Masks & Wedding Masks

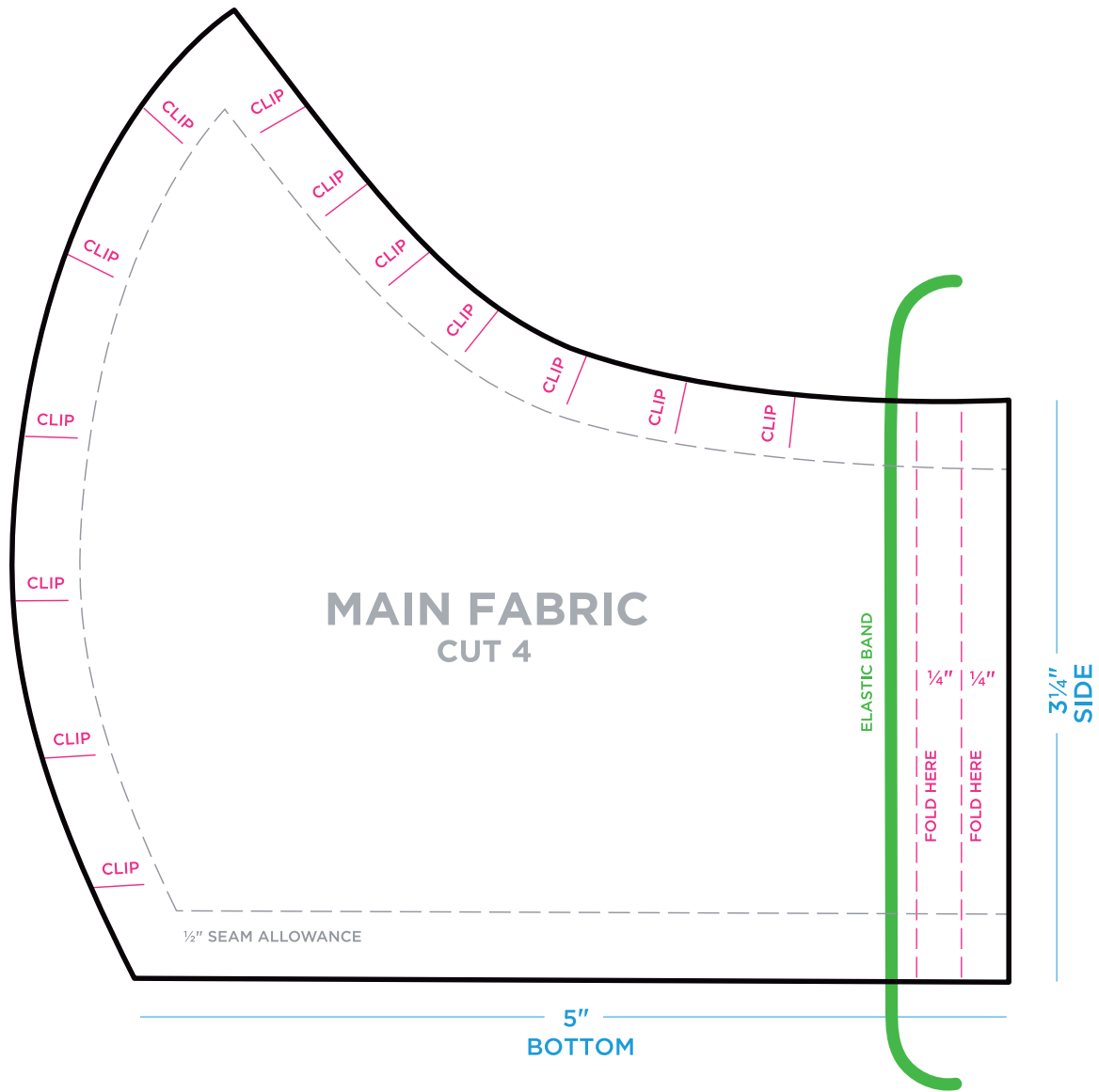

CONE FACE MASK PATTERN

LARGE/X-LARGE

SCALED AT 100%

This Pattern Works For:

St. Patrick's Day, Valentine's Day, 4th of July,
Fall Masks & Wedding Masks

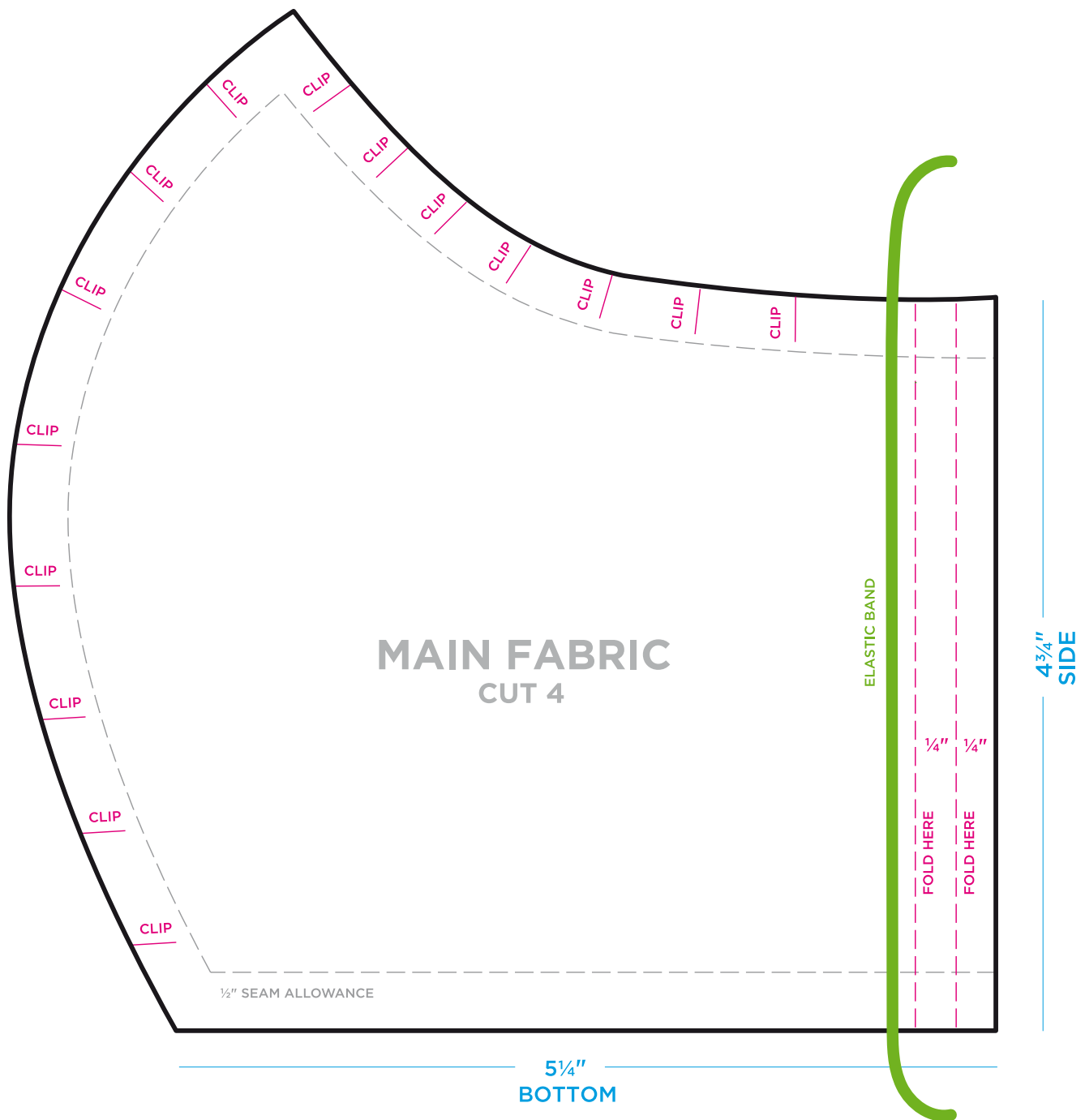

FACE SHIELD PATTERN

ASTRONAUT (1 of 3)

SCALED AT 65%
See 2-3 for full-size template

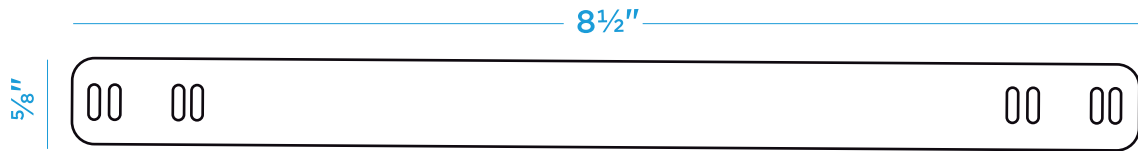

FOREHEAD STRAP

CUT 1 PLASTIC
CUT 1 FOAM

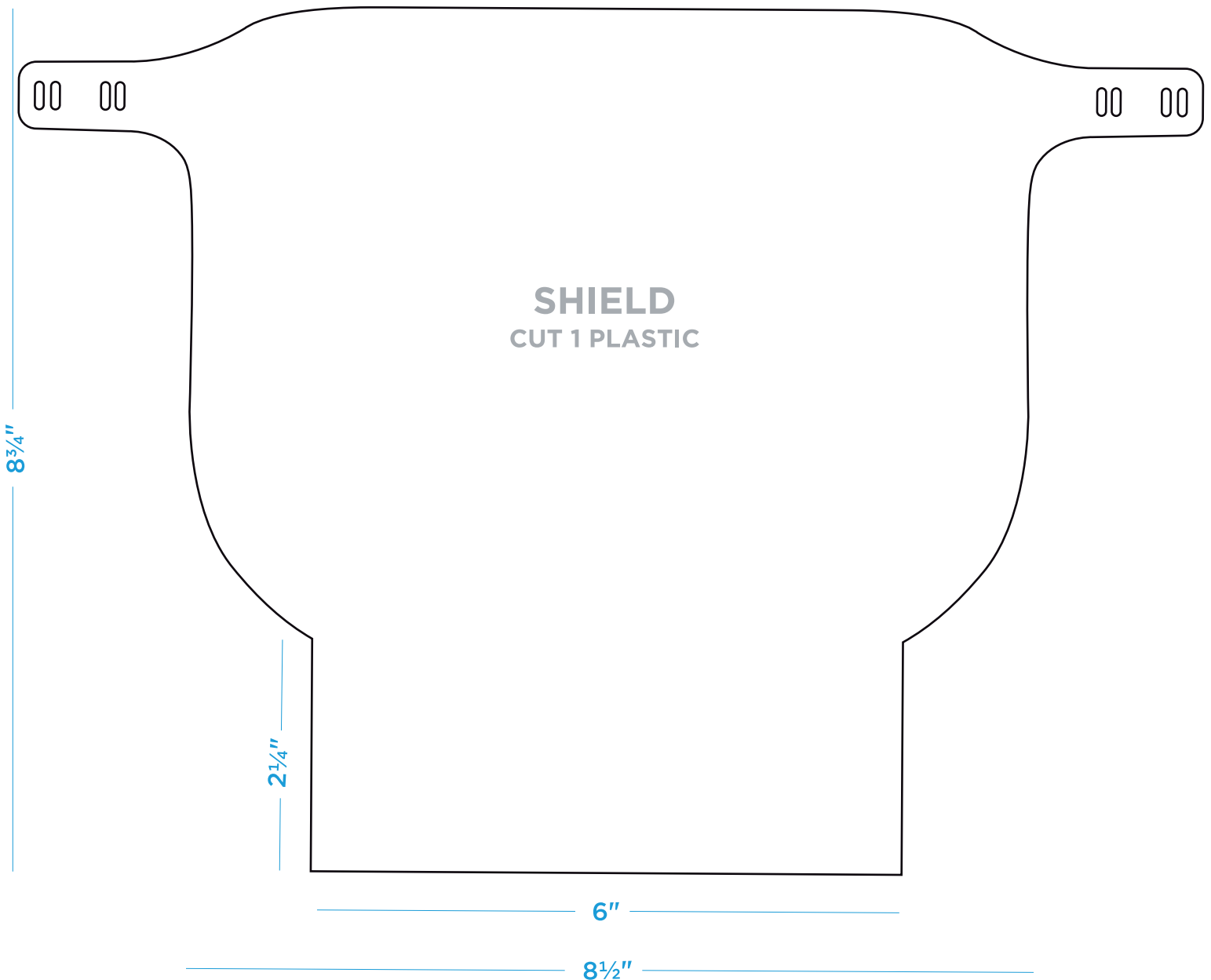

SHIELD

CUT 1 PLASTIC

FACE SHIELD PATTERN

ASTRONAUT (2 of 3)

For full-size template,
cut out all pieces

Align arrow ends and
tape template together



FOREHEAD STRAP
CUT 1 PLASTIC
CUT 1 FOAM

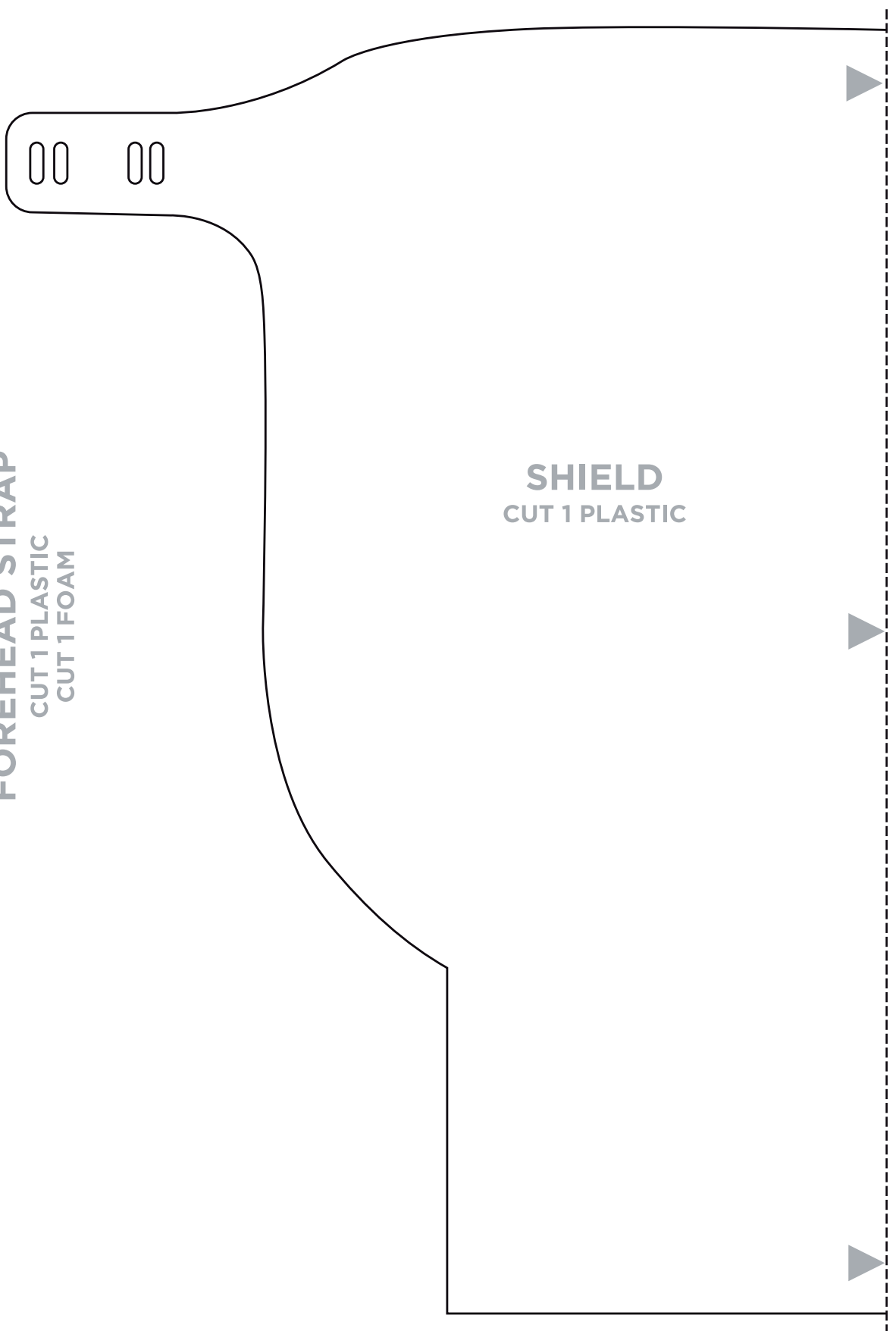

SHIELD
CUT 1 PLASTIC

FACE SHIELD PATTERN

ASTRONAUT (3 of 3)

For full-size template,
cut out all pieces

Align arrow ends and
tape template together

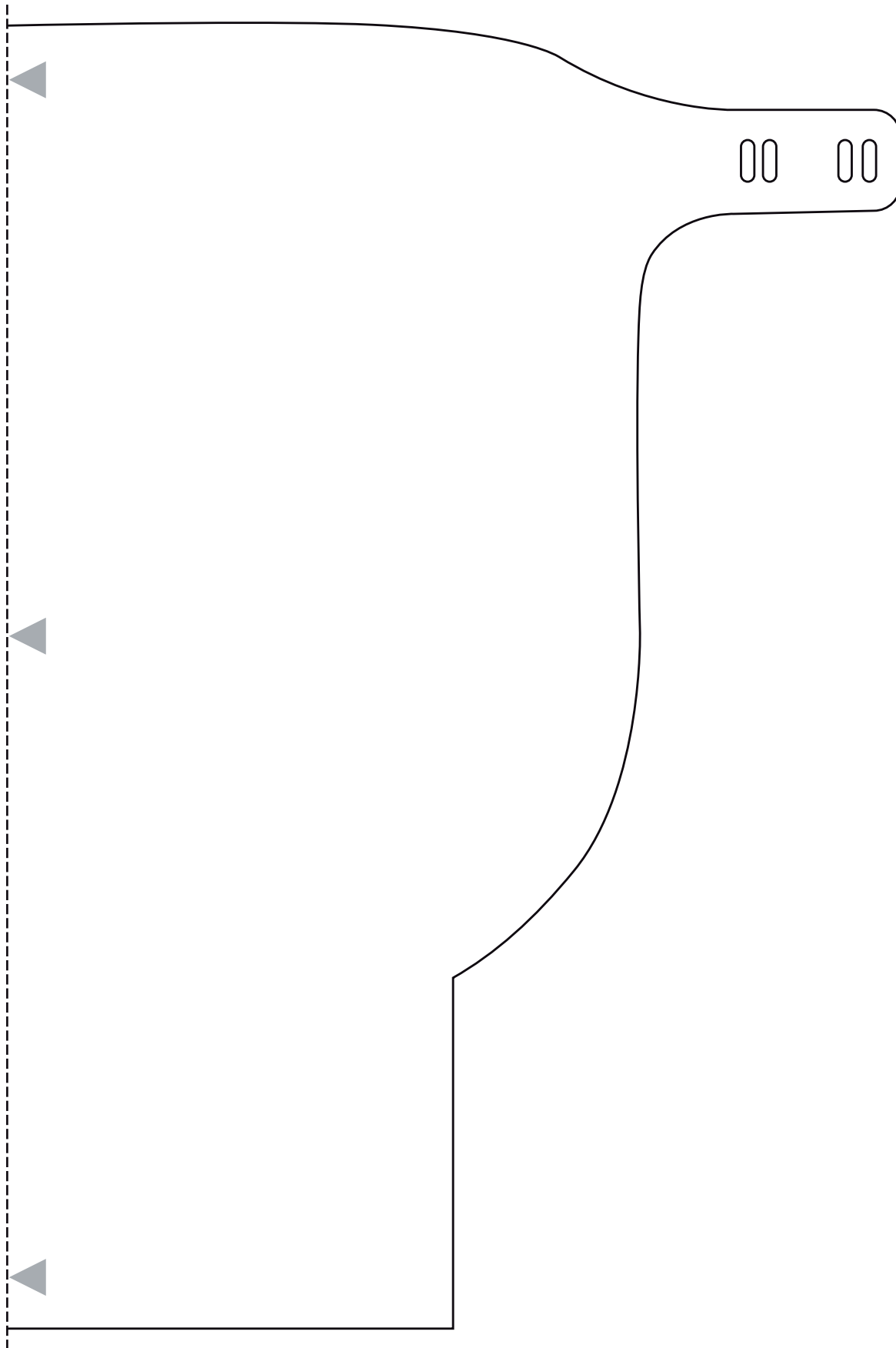

FACE SHIELD PATTERN

PRINCESS CROWN (1 of 3)

SCALED AT 65%
See 2-3 for full-size template

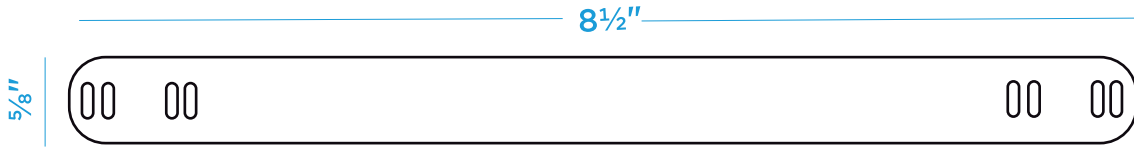

FOREHEAD STRAP

CUT 1 PLASTIC
CUT 1 FOAM

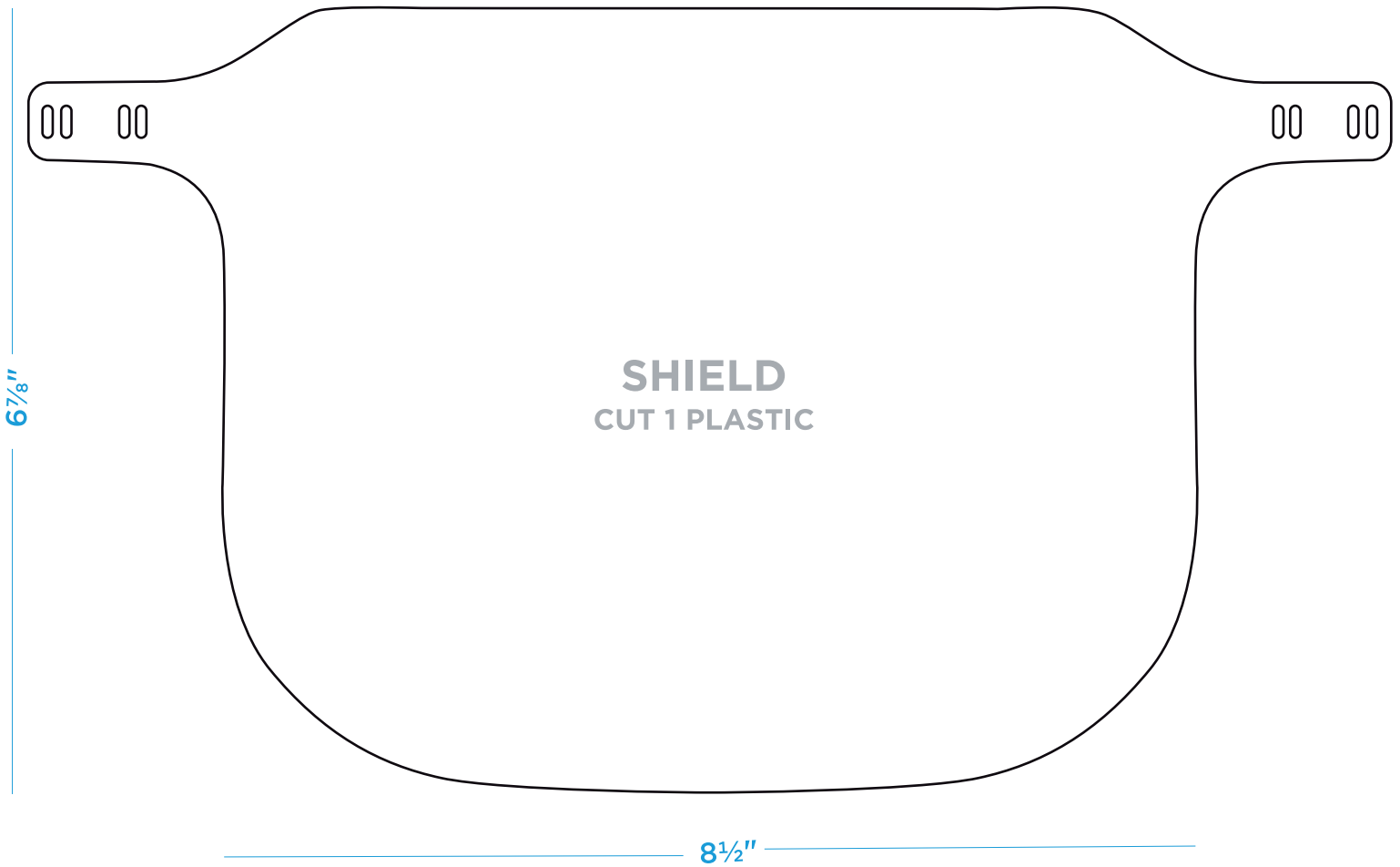

SHIELD

CUT 1 PLASTIC

FACE SHIELD PATTERN

PRINCESS CROWN (2 of 3)

For full-size template,
cut out all pieces

Align arrow ends and
tape template together



FOREHEAD STRAP
CUT 1 PLASTIC
CUT 1 FOAM

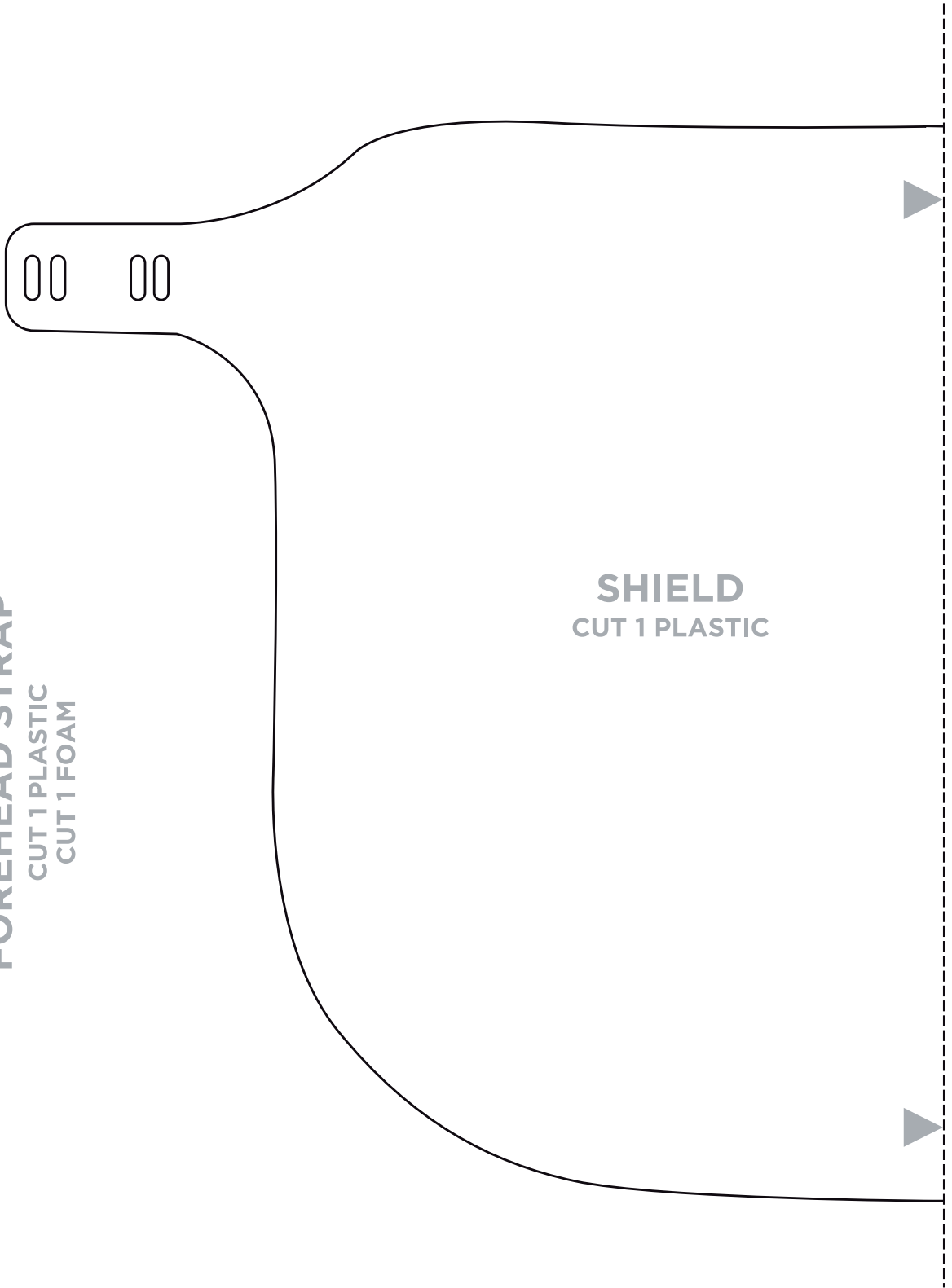

SHIELD
CUT 1 PLASTIC

FACE SHIELD PATTERN

PRINCESS CROWN (3 of 3)

For full-size template,
cut out all pieces

Align arrow ends and
tape template together

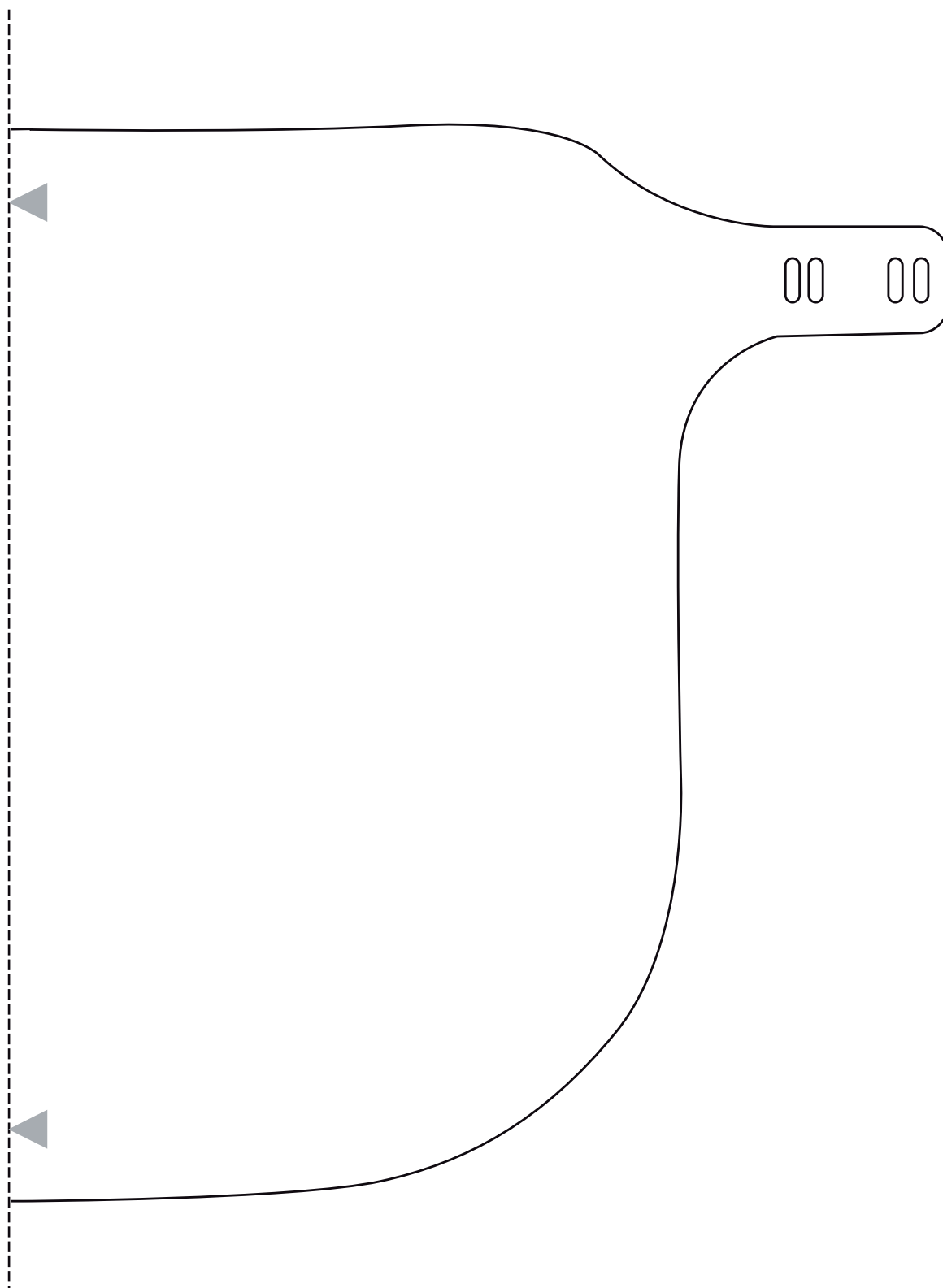

FAUX KNOT HEADBAND PATTERN

4th OF JULY (2 of 3)

SCALED AT 60%

See 2-3 for full-size template

Pair with Cone Face Mask Pattern

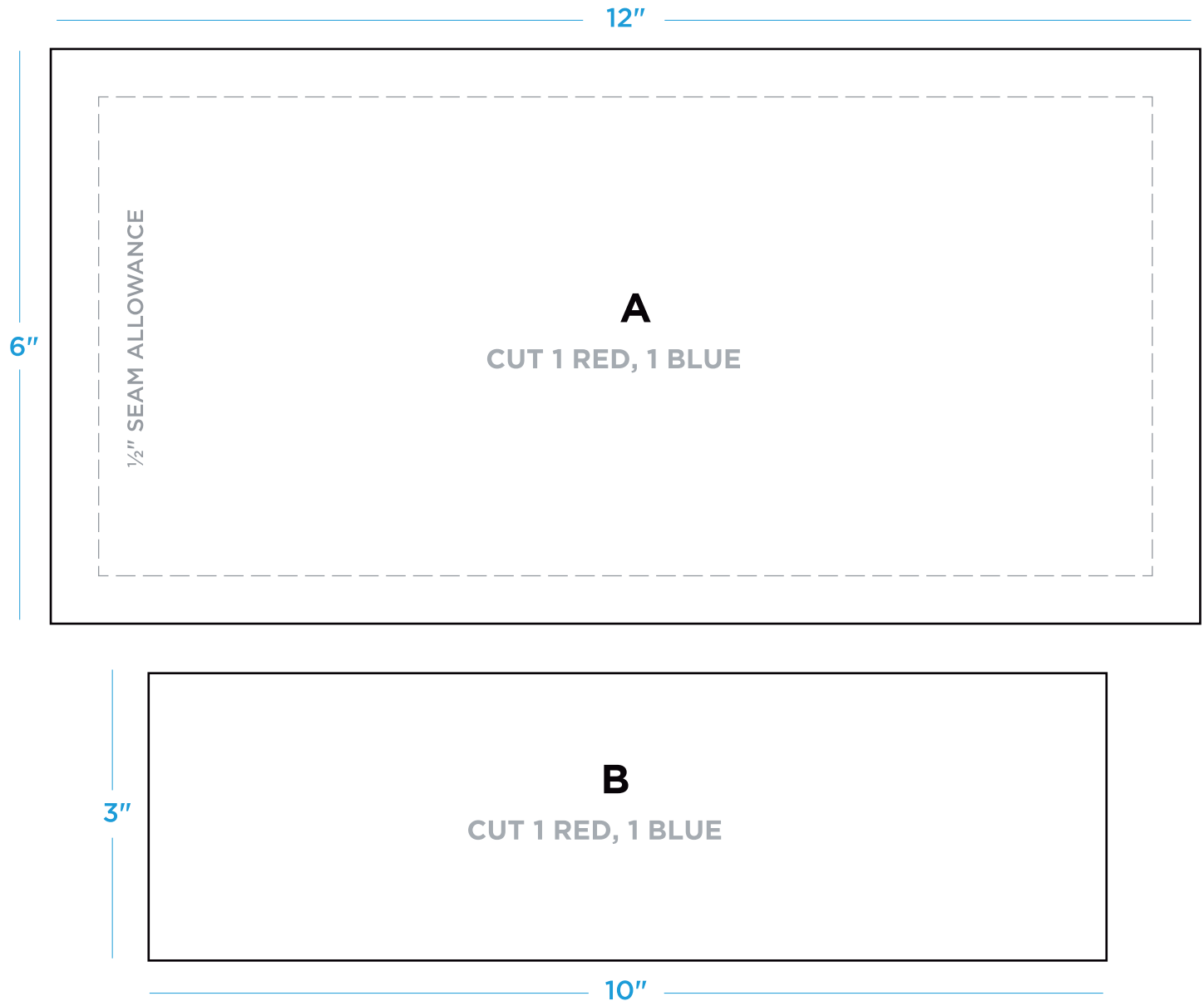

1. Place red Piece B and blue Piece B right sides together and sew down one short side. Press seam flat.
2. Fold lengthwise with right sides together and sew across long side. Turn.
3. Insert elastic and stitch at each end to hold.
4. Fold red Piece A lengthwise with right sides together and sew across long side. Turn. Repeat with blue Piece A.
5. Wrap red Piece A around red end of Piece B and pin. Stitch and backstitch to secure. Pull backwards over seam. Repeat with blue pieces.
6. Fold band in half, offsetting edges so bottom edge of one end matches middle seam on other end. Wrap top portion around to bottom and vice versa. Pin to secure. Stitch through all layers in a curved line.
7. Pull fabric away from seam to create faux knot.

FAUX KNOT HEADBAND PATTERN

4th OF JULY (2 of 3)

For full-size template,
cut out all pieces

Align arrow ends and
tape template together

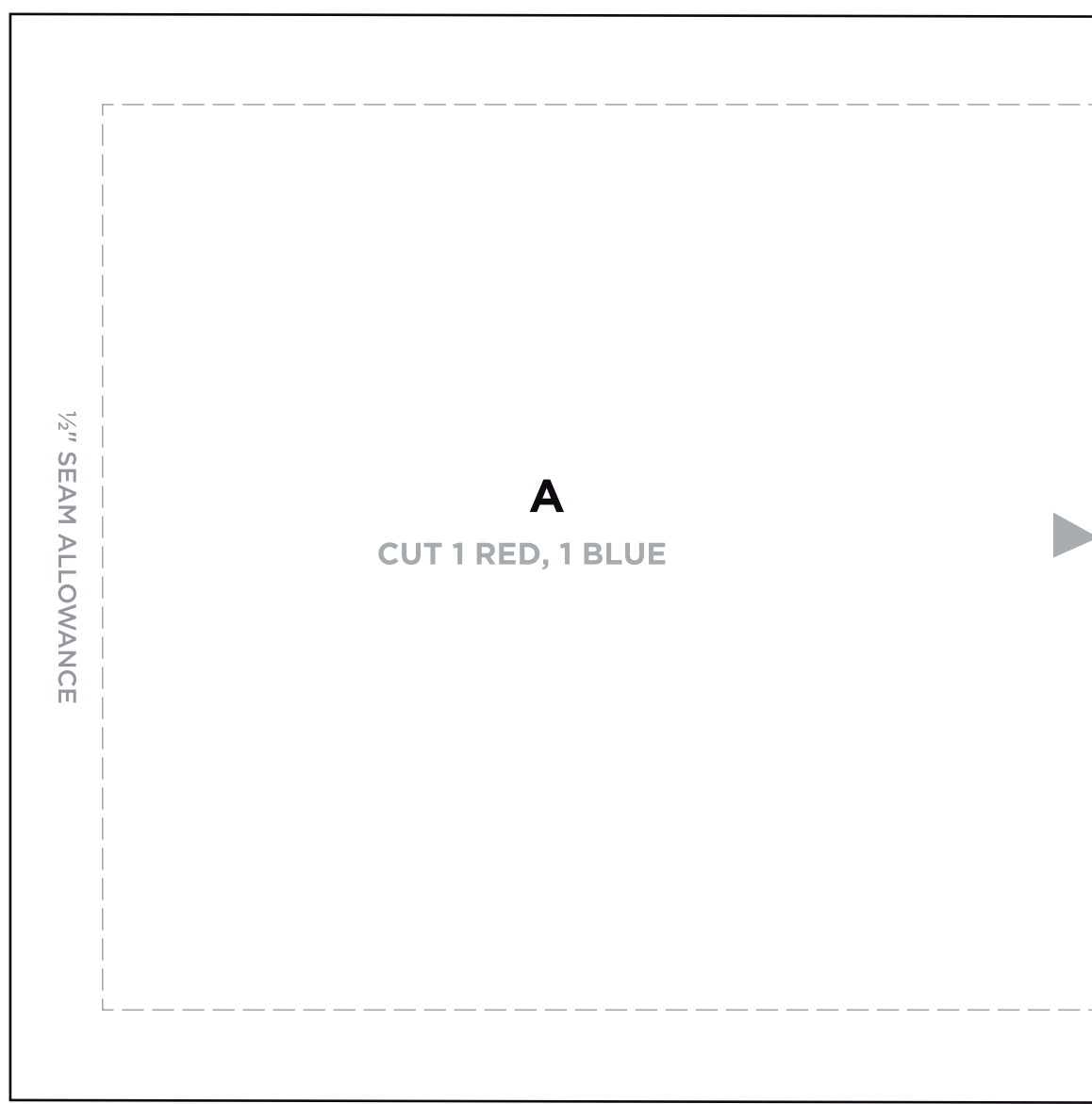

FAUX KNOT HEADBAND PATTERN

4th OF JULY (3 of 3)

For full-size template,
cut out all pieces

Align arrow ends and
tape template together

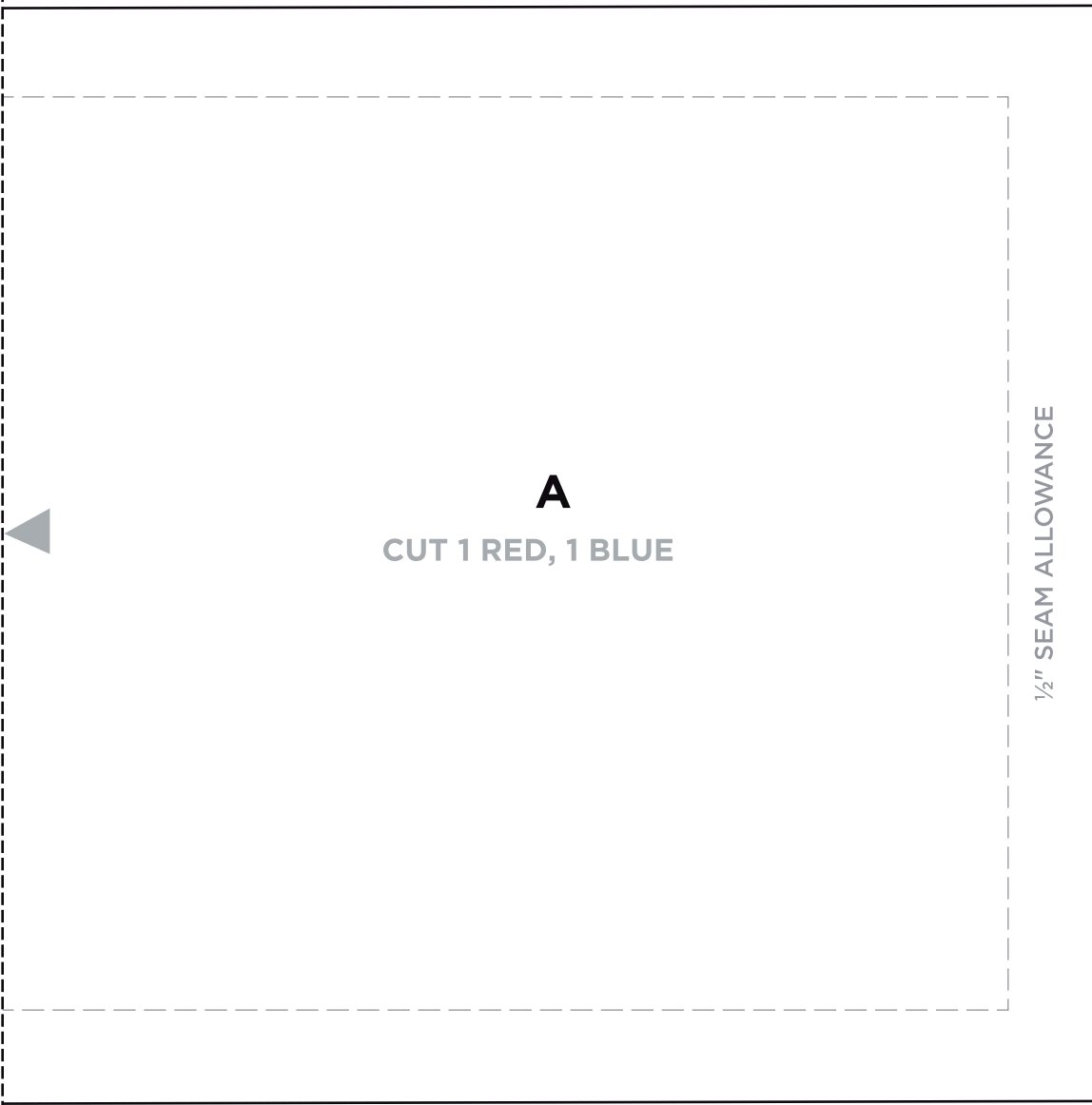
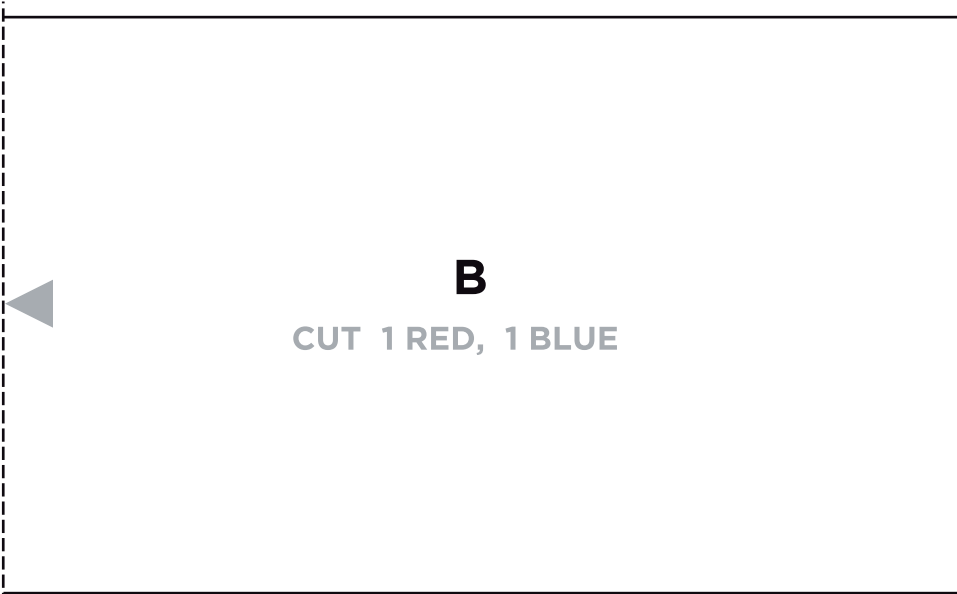

NECK GAITER PATTERN

CHILD SIZE

SCALED AT 50%

This Pattern Works For:
Animal Hoodies

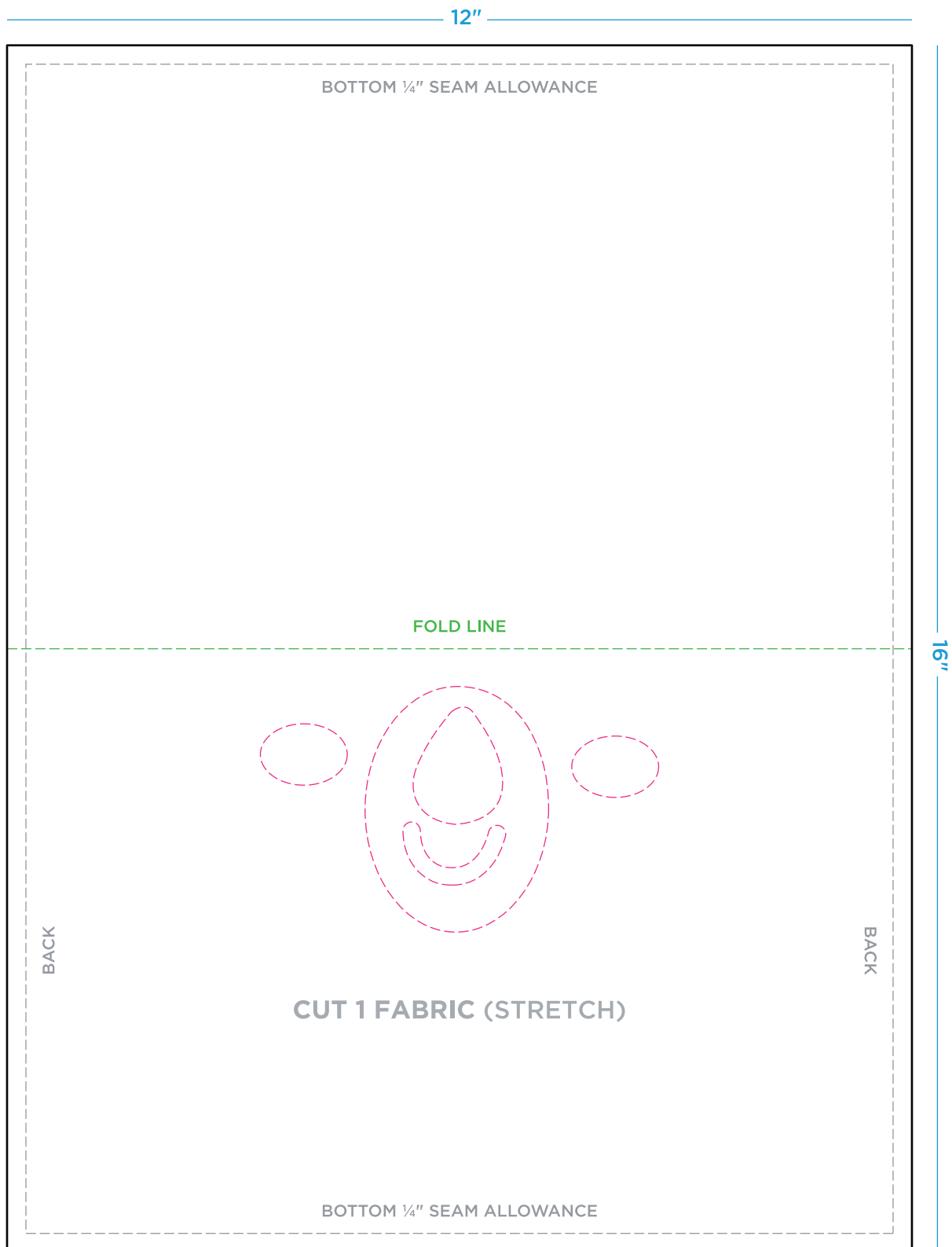

1. Sew back to make a tube.
2. Sew bottom to make a lined tube.

FACE MASK PATTERN

ANIMAL FACES (1 of 1)

SCALED AT 100%

Pairs with Neck Gaiter

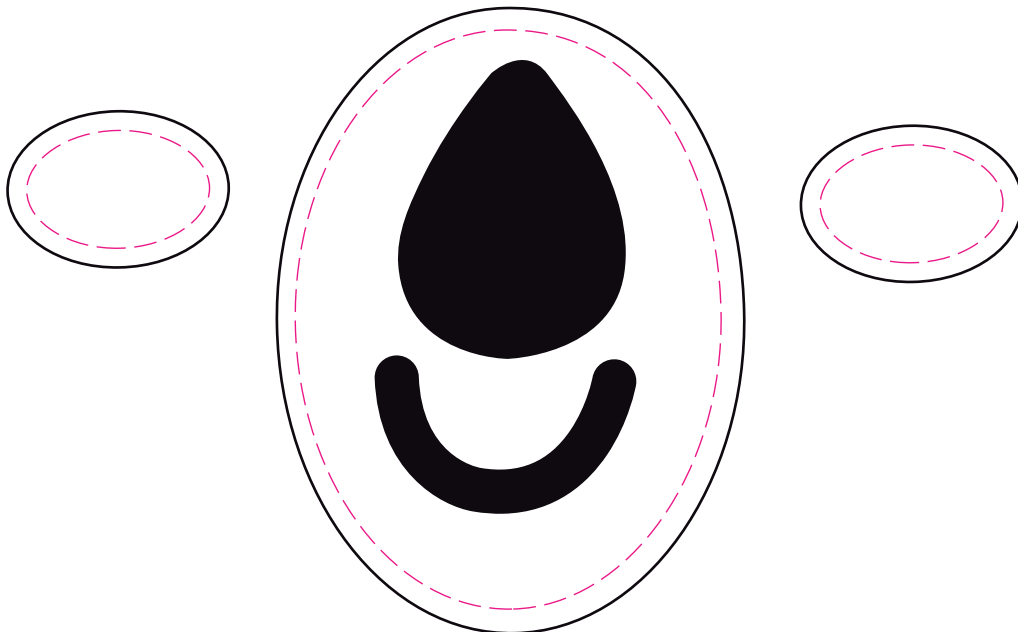
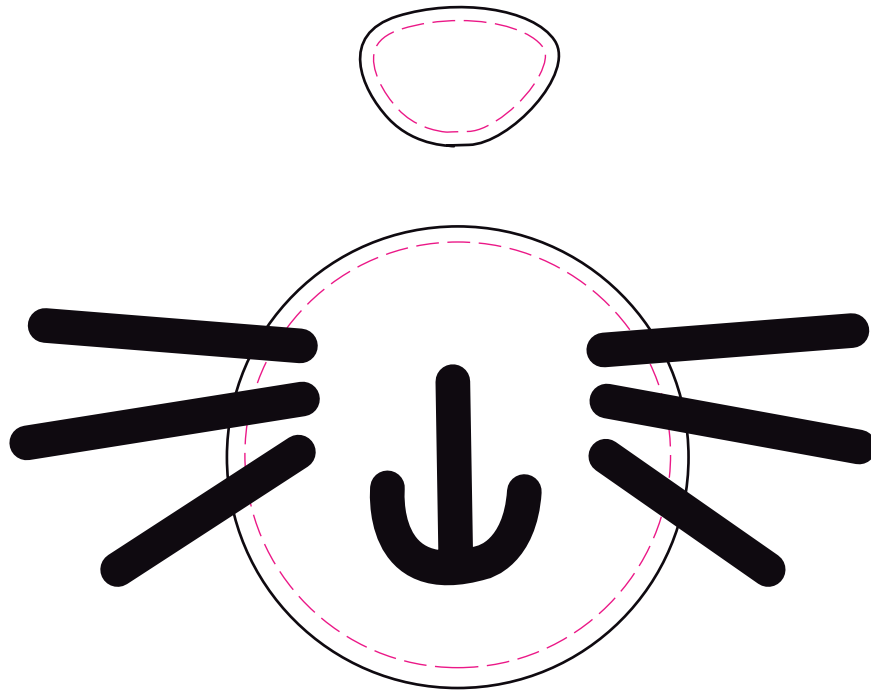

STRAP & SANITIZER PATTERN

SCALED AT 100%

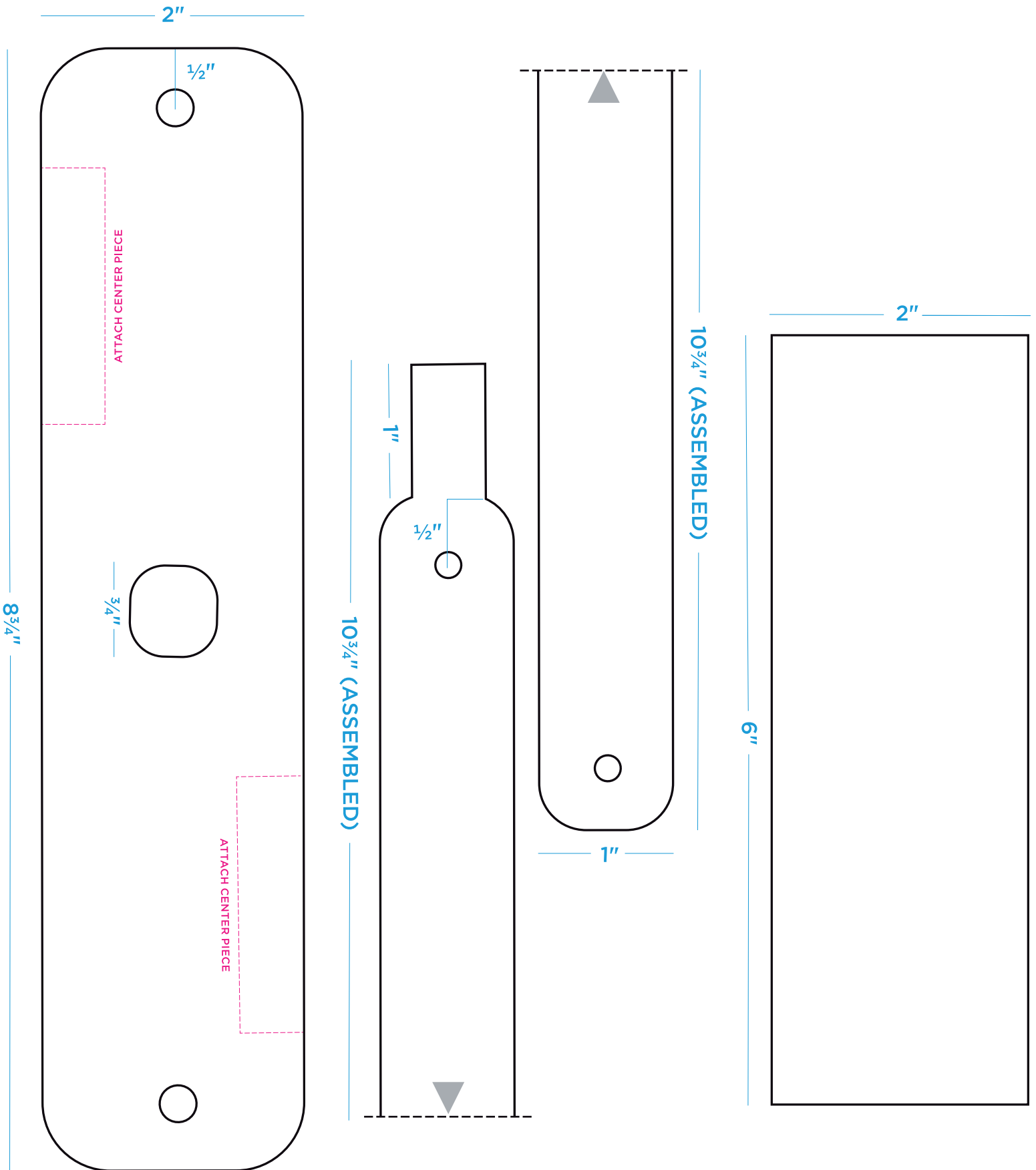

MASK HOLDER PATTERN

(1 of 4)

SCALED AT 33%
See 4 for full-size Piece 3 template

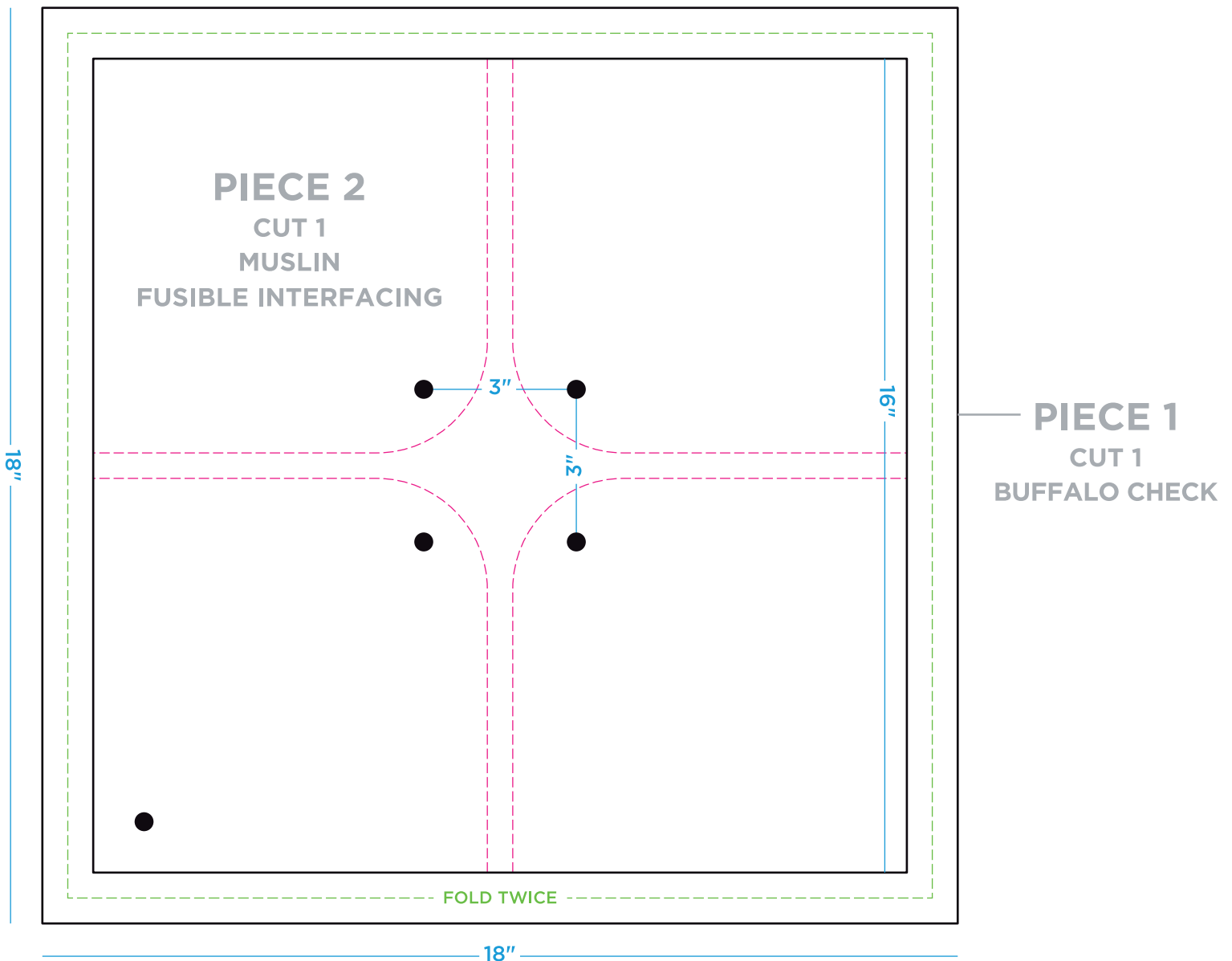
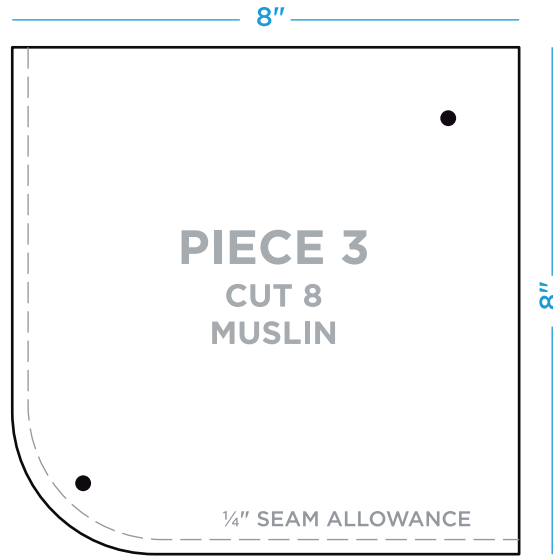

MASK HOLDER PATTERN

(2 of 4)

SCALED AT 40%

PIECE 1
CUT 1
BUFFALO CHECK

18"

18"

MASK HOLDER PATTERN

(3 of 4)

SCALED AT 40%

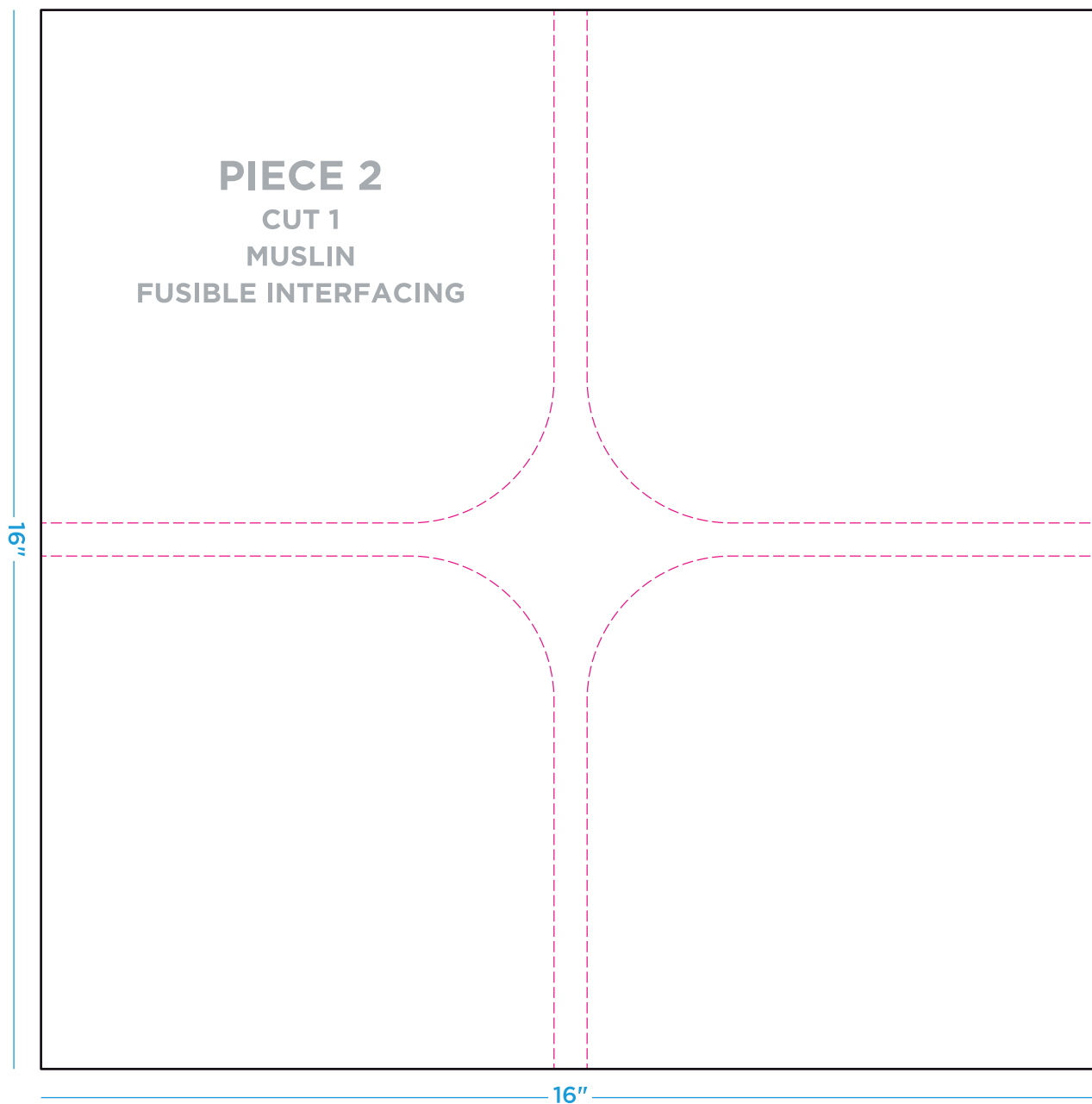

MASK HOLDER PATTERN

(4 of 4)

SCALED AT 100%

